

PURUS AB

Södergatan 7
SE-275 31 Sjöbo
Sweden

Tel: 00 46 416 257 00 Fax: 00 46 416 257 20
e-mail: yh@purus.se
website: www.purus.se



Agrément Certificate

09/4647

Product Sheet 1

PURUS FLOOR GULLIES

PRODUCT SCOPE AND SUMMARY OF CERTIFICATE

This Certificate of Confirmation relates to Purus Floor Gullies, for use inside buildings to receive wastewater from floors in wet rooms and walk-in showers.

AGRÉMENT CERTIFICATION INCLUDES:

- factors relating to compliance with Building Regulations where applicable
- factors relating to additional non-regulatory information where applicable
- independently verified technical specification
- assessment criteria and technical investigations
- design considerations
- installation guidance
- regular surveillance of production
- formal three-yearly review.



KEY FACTORS ASSESSED

Mechanical resistance and stability — the products will have adequate strength to resist the loads experienced under normal service conditions (see section 5).

Hygiene, health and the environment — the products will allow disposal of wastewater without clogging (see section 6).

Safety in use — the products are safe in use (see section 7).

Durability — the products will have adequate durability (see section 9).

The BBA has awarded this Agrément Certificate to the company named above for the products described herein. These products have been assessed by the BBA as being fit for their intended use provided they are installed, used and maintained as set out in this Certificate.

On behalf of the British Board of Agrément

Brian Chamberlain
Head of Approvals — Engineering

Greg Cooper
Chief Executive

Date of First issue: 3 April 2009

The BBA is a UKAS accredited certification body — Number 113. The schedule of the current scope of accreditation for product certification is available in pdf format via the UKAS link on the BBA website at www.bbacerts.co.uk

Readers are advised to check the validity and latest issue number of this Agrément Certificate by either referring to the BBA website or contacting the BBA direct.

British Board of Agrément
Bucknalls Lane
Garston, Watford
Herts WD25 9BA

©2009

tel: 01923 665300
fax: 01923 665301
e-mail: mail@bba.star.co.uk
website: www.bbacerts.co.uk

Regulations

In the opinion of the BBA, Purus Floor Gullies, if used in accordance with the provisions of this Certificate, will meet or contribute to meeting the relevant requirements of the following Building Regulations:



The Building Regulations 2000 (as amended) (England and Wales)

Requirement:	H1(1)	Foul water drainage
Comment:		The products will contribute to meeting the regulatory requirements. See sections 6.1 to 6.5 of this Certificate.
Requirement:	Regulation 7	Materials and workmanship
Comment:		The products are acceptable. See sections 9.1 to 9.4 and the <i>Installation</i> part of this Certificate.



The Building (Scotland) Regulations 2004 (as amended)

Regulation:	8(1)(2)	Fitness and durability of materials and workmanship
Comment:		The products satisfy the requirements of this Regulation, with reference to clauses 0.8.2 ⁽¹⁾ to 0.8.4 ⁽¹⁾ . See sections 8.1 to 8.4, 9.1 to 9.4 and the <i>Installation</i> part of this Certificate.
Regulation:	9	Building standards – construction
Standard:	3.7(b)	Wastewater drainage
Comment:		The products will contribute to meeting the requirements of this Standard, with reference to clause 3.7.1 ⁽¹⁾ . See sections 6.1 to 6.5 of this Certificate.
		(1) Technical Handbook (Domestic).



The Building Regulations (Northern Ireland) 2000 (as amended)

Regulation:	B2(a)(i)	Fitness of materials and workmanship
Comment:		The products are acceptable. See sections 9.1 to 9.4 and the <i>Installation</i> part of this Certificate.
Regulation:	B3(2)	Suitability of certain materials
Comment:		The products are acceptable. See sections 8.1 to 8.4 of this Certificate.
Regulation:	N4(a)(i)(b)	Underground foul drainage
Comment:		The products will contribute to meeting the stated requirements. See sections 6.1 to 6.5 of this Certificate.

Construction (Design and Management) Regulations 2007

Construction (Design and Management) Regulations (Northern Ireland) 2007

Information in this Certificate may assist the client, CDM co-ordinator, designer and contractors to address their obligations under these Regulations.

See section: 7 *Safety in use* (7.1 and 7.2).

Non-regulatory Information

NHBC Standards 2008

NHBC accepts the use of Purus Floor Gullies, when installed and used in accordance with this Certificate, in relation to *NHBC Standards*, Chapter 8.1 *Soil and waste systems*, D16 and D17.

Zurich Building Guarantee Technical Manual 2007

In the opinion of the BBA, Purus Floor Gullies, when installed and used in accordance with this Certificate, satisfy the requirements of the *Zurich Building Guarantee Technical Manual*, Section 3 *Substructure*, sub-section *Drainage*.

General

This Certificate relates to Purus Floor Gullies for internal use to receive wastewater from floors in wet rooms and walk-in showers.

The products are for use inside domestic, commercial and public buildings with gravity drainage systems installed in accordance with BS EN 12056-1 : 2000, BS EN 12056-2 : 2000, BS EN 12056-3 : 2000 and BS EN 12056-5 : 2000 for the conveyance of surface water and domestic sewage as is permitted to be discharged into public sewers by the Water Industry Act 1991, and surface water and sewage as is permitted and defined by the Sewerage (Scotland) Act 1968 and the Water and Sewerage Services (Northern Ireland) Order 1973.

It is important for designers, planners, contractors and/or installers to ensure that the installation of the gullies is in accordance with the Certificate holder's instructions and the information given in this Certificate.

The products are manufactured in Sweden by the Certificate holder and marketed in the UK by Purus Ltd.

This Certificate is a Confirmation of the Swedish Technical Approvals issued by SITAC⁽¹⁾ to Purus AB.

(1) Swedish Institute for Technical Approval in Construction.

Technical Specification

1 Description

1.1 The Purus Floor Gullies covered by this Certificate are available in plastic, stainless steel and epoxy-coated cast iron, in various types and sizes as detailed in Tables 1 to 16.

Table 1 Details of HEAVY

Product code	Description	Material	Outlet diameter (mm)	Capacity (ls ⁻¹)
710 28 36	HEAVY 75 R	stainless steel	75	3.0
710 28 30	HEAVY 75 P	stainless steel/ plastic	75	3.0
710 28 37	HEAVY 110 R	stainless steel	110	6.0
710 28 29	HEAVY 110 P	stainless steel/ plastic	110	6.0

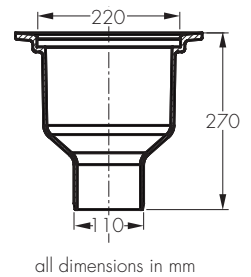

Table 2 Details of BIGG

Product code	Description	Material	Outlet diameter (mm)	Capacity (ls ⁻¹)
710 28 34	BIGG 75 R	stainless steel	75	3.0
710 28 22	BIGG 75 P	stainless steel/ plastic	75	3.0
710 28 35	BIGG 110 R	stainless steel	110	6.0
710 28 21	BIGG 110 P	stainless steel/ plastic	110	6.0

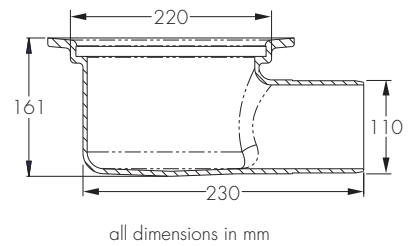

Table 3 Details of LOD

Product code	Description	Material	Outlet diameter (mm)	Capacity (ls ⁻¹)
710 21 74	LOD 50 E, bottom outlet ⁽¹⁾	cast iron/ plastic	50	2.0
710 21 72	LOD MA 75 E, bottom outlet ⁽¹⁾	cast iron/ plastic	75	3.0

(1) Including clamping ring and grating.

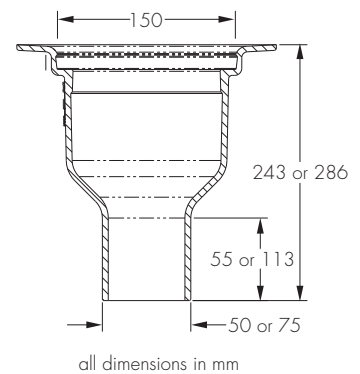

Table 4 Details of S/50 L MA 75 E

Product code	Description	Material	Outlet diameter (mm)	Capacity (ls ⁻¹)
710 26 51	S/50 L MA 75 E, side outlet ⁽¹⁾	cast iron/ plastic	75	3.0

(1) Including clamping ring and grating.

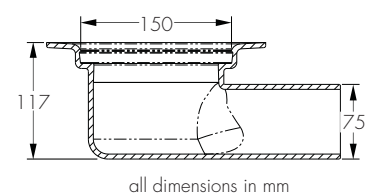
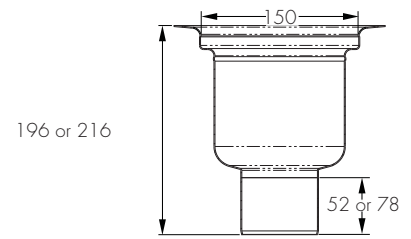

Table 5 Details of BALDER

Product code	Description	Material	Outlet diameter (mm)	Capacity (ls ⁻¹)
711 80 89	BALDER 50 R ⁽¹⁾	stainless steel	50	2.0
711 80 90	BALDER 50 P ⁽¹⁾	plastic	50	2.0
711 80 81	BALDER 75 R ⁽¹⁾	stainless steel	75	3.0
711 80 70	BALDER 75 P ⁽¹⁾	plastic	75	3.0

(1) Including clamping ring and grating.



all dimensions in mm

Table 6 Details of SIGYN

Product code	Description	Material	Outlet diameter (mm)	Capacity (ls ⁻¹)
711 80 91	SIGYN 50 R ⁽¹⁾	stainless steel	50	2.0
711 80 92	SIGYN 50 P ⁽¹⁾	plastic	50	2.0
711 80 85	SIGYN 75 R ⁽¹⁾	stainless steel	75	3.0
711 80 71	SIGYN 75 P ⁽¹⁾	plastic	75	3.0

(1) Including clamping ring and grating.

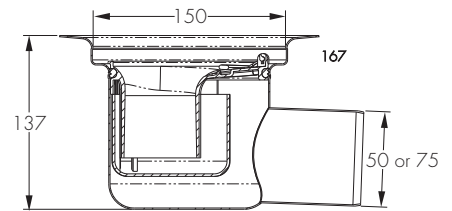

all dimensions in mm

Table 7 Details of BRAGE MINI/ODEN MINI

Product code	Description	Material	Outlet diameter (mm)	Capacity (ls ⁻¹)
711 35 38	BRAGE MINI 110	polypropylene	110	6.0
711 35 36	BRAGE MINI 50	polypropylene	50	2.0
711 35 35	ODEN MINI 50	polypropylene	50	2.0



Table 8 Details of VAKE

Product code	Description	Material	Outlet diameter (mm)	Capacity (ls ⁻¹)
711 35 80	VAKE ⁽¹⁾	polypropylene	75	3.0

(1) Including clamping ring and grating.

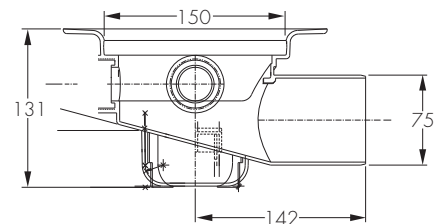

all dimensions in mm

Table 9 Details of VAGE

Product code	Description	Material	Outlet diameter (mm)	Capacity (ls ⁻¹)
711 35 98	VAGE ⁽¹⁾	polypropylene	75	3.0

(1) Including clamping ring and grating.

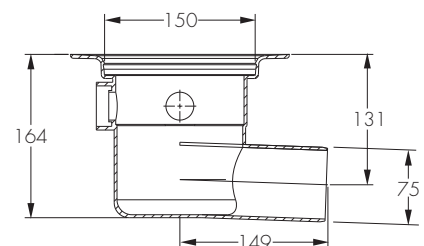

all dimensions in mm

Table 10 Details of FLEX

Product code	Description	Material	Outlet diameter (mm)	Capacity (ls ⁻¹)
711 35 91	FLEX ⁽¹⁾	polypropylene	75	3.0

(1) Including clamping ring and grating.

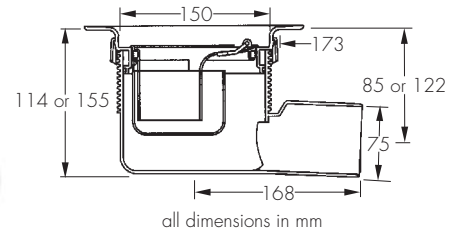

Table 11 Details of LOKE

Product code	Description	Material	Outlet diameter (mm)	Capacity (ls ⁻¹)
711 35 88	LOKE ⁽¹⁾	polypropylene	75/110	3.0

(1) Including clamping ring and grating.

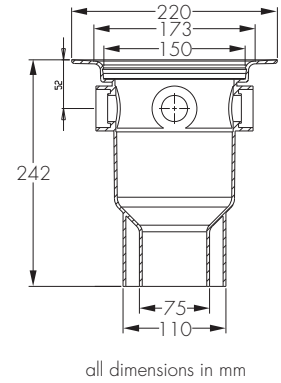

Table 12 Details of DUSCHBRUNN

Product code	Description	Material	Outlet diameter (mm)	Capacity (ls ⁻¹)
711 35 27	SHOWER GULLY ⁽¹⁾	ABS plastic	50	2.0

(1) Including clamping ring and grating.

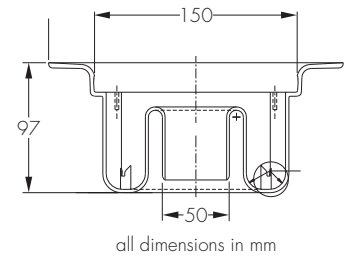

Table 13 Details of BRAGE

Product code	Description	Material	Outlet diameter (mm)	Capacity (ls ⁻¹)
711 39 27	BRAGE 50 ⁽¹⁾	ABS plastic	50	2.0
711 39 29	BRAGE 75 KM ⁽¹⁾	polyethylene	75	3.0
711 39 25	BRAGE 75 ⁽¹⁾	ABS plastic	75	3.0
711 39 30	BRAGE 75 PP ⁽¹⁾	polypropylene	75	3.0
711 39 28	BRAGE 110 ⁽¹⁾	polyethylene	110	6.0

(1) Including clamping ring and grating.

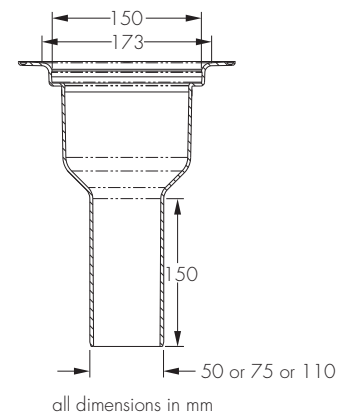

Table 14 Details of ODEN

Product code	Description	Material	Outlet diameter (mm)	Capacity (ls ⁻¹)
711 35 22	ODEN ⁽¹⁾	polypropylene	75	3.0

(1) Including clamping ring and grating.

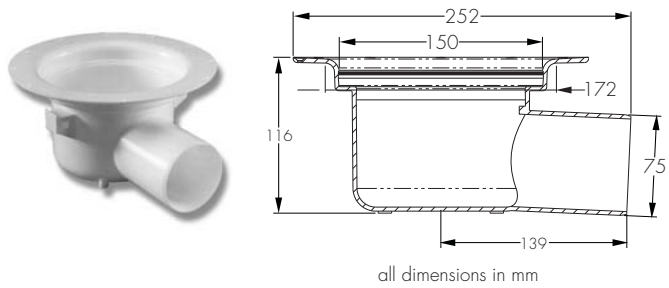

Table 15 Details of LINE/CORNER

Product code	Description (mm)	Material	Outlet diameter (mm)	Capacity (ls ⁻¹)
711 37 09	LINE: in lengths of 300, 600, 700, 800, 900 or 1000	stainless steel	75	3.0
	CORNER: triangle dimensions of 300 x 300 x 420	stainless steel	75	3.0

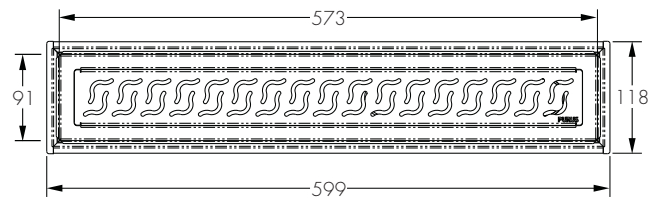
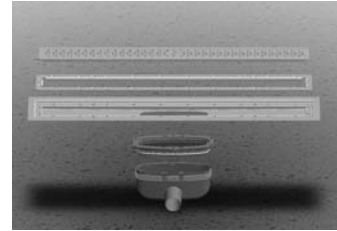
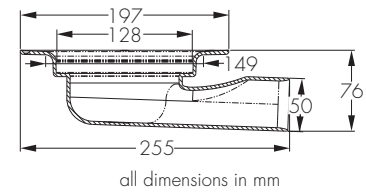

Table 16 Details of MINIMAX

Product code	Description	Material	Outlet diameter (mm)	Capacity (ls ⁻¹)
711 37 64	MINIMAX 50	polypropylene	50/75	2.0
711 37 65	MINIMAX TRAP	polypropylene	50/75	2.0



1.2 Extension rings allow the gully height to be varied to suit the application (see Tables 17 and 18).

Table 17 Details of extension rings (FHP)

Product code	Description	Material	diameter x height (mm)
713 36 25	FHP/13	ABS plastic	150 x 13
713 36 14	FHP/25	ABS plastic	150 x 25
713 36 22	FHP/50	ABS plastic	150 x 50
713 36 48	FHP/100	ABS plastic	150 x 100

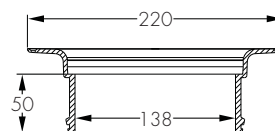
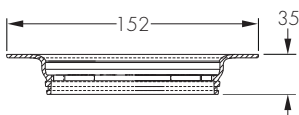

all dimensions in mm

Table 18 Details of extension ring (FHP/FLEX)

Product code	Description	Material	diameter x height (mm)
713 36 49	FHP/FLEX	ABS plastic	150 x 35 to 107



1.3 Continuous quality control is exercised during manufacture including regular checks on appearance, dimensions, marking and loading classification. An inspection body on behalf of SITAC is responsible for ensuring that product quality is maintained.

1.4 The gullies and their accessories are marked with the manufacturer's name, product type, code, date of manufacture and approval number.

2 Delivery and site handling

2.1 Purus Floor Gullies are supplied in cardboard boxes.

2.2 The products are of robust construction but rough handling (eg dropping on hard floor) may cause distortion of such features as seals, grating, extension rings. Damaged items should be discarded.

Assessment and Technical Investigations

The following is a summary of the assessment and technical investigations carried out on Purus Floor Gullies.

Design Considerations

3 General

Purus Floor Gullies are satisfactory for use as receptacles located inside buildings for disposing of wastewater from floors in wet rooms and walk-in showers.

4 Practicability of installation

4.1 These products are designed to be installed by a competent general builder, or a contractor, experienced with these type of products.

4.2 The products can be installed in either timber or concrete floors using purpose-made accessories.

5 Mechanical resistance and stability

5.1 The gullies will have adequate resistance to the loadings likely to be experienced under normal service conditions in the areas of use as defined in this Certificate.

5.2 The gratings, extension rings and clamping rings will have adequate strength and stability.

5.3 The products may be regarded as having a Class K 3 rating in accordance with BS EN 1253-1 : 2003.

6 Hygiene, health and the environment



6.1 The floor gullies have adequate flow characteristics and will allow disposal of wastewater without clogging.

6.2 The products will provide water seal depths in excess of 50 mm.

6.3 Trapped gullies and gully bodies have adequate odour and watertightness.

6.4 Products for use with sheet floor covering will have adequate watertightness.

6.5 If an extension ring is used, the joint between the ring and the gully body will provide a watertight seal.

6.6 In a fire, gullies made of polypropylene will burn to form carbon dioxide and water.

7 Safety in use

7.1 The products are free from sharp edges that can impair performance or cause injury to persons.

7.2 The gratings have apertures suitable for adequate performance and safety.

8 Maintenance



8.1 Sections of the floor gullies can be removed easily for cleaning or replacement.

8.2 With traps removed, the pipework can be rodded easily using either cane or polypropylene rods with a cleaning coil head.

8.3 The removable traps are cleaned easily using a soft brush (see Figure 1).

Figure 1 Maintenance

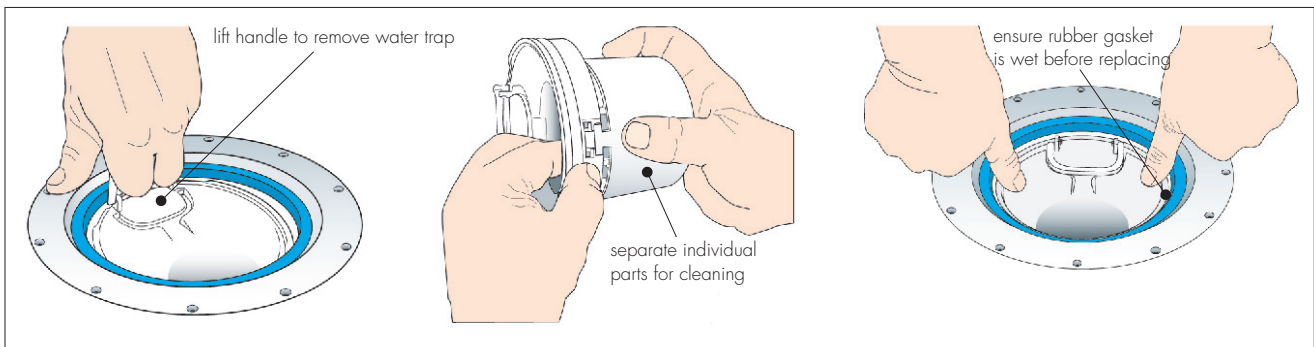

8.4 Adequate access for cleaning is provided on gullies so equipped. Trapped gullies which cannot be cleaned through a cleaning port or by removing the trap will have satisfactory performance.

9 Durability



9.1 When used within the conditions and recommendations given in this Certificate, the products will have adequate durability.

9.2 The products will resist all thermal cycling conditions likely to occur in effluents from the areas of use defined in this Certificate. In particular, gullies for use with sheet floor covering can adequately resist such conditions.

9.3 The products are resistant to corrosion.

9.4 The products will be unaffected by the types and quantities of chemicals likely to be found in wastewater from wet floors or effluents from domestic appliances.

Installation

10 General

10.1 Installation must be carried out in accordance with the Certificate holder's instructions and BS EN 12056-1 : 2000, BS EN 12056-2 : 2000 and BS EN 12056-3 : 2000 and BS EN 12056-5 : 2000.

10.2 Floors fitted with Purus Floor Gullies must be designed to allow the water to flow freely to the gratings and incorporate an effective damp-proof membrane in accordance with CP 102 : 1973, BS 8102 : 1990 and BS 8215 : 1991.

11 Procedure

Timber floors

11.1 Support trimmers are fixed to the main floor joists to suit gully dimensions (see Figure 2).

Figure 2 Installation in timber floors

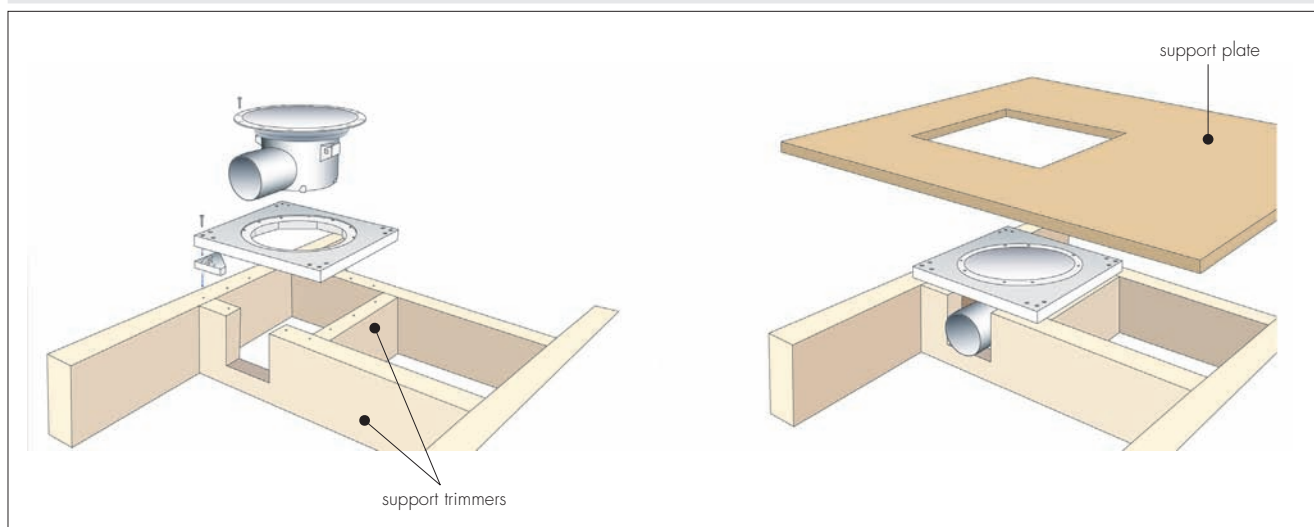

11.2 A purpose made support plate is fixed to the trimmers/joists with galvanized or stainless steel screws.

11.3 The gully body is positioned under the support plate and, after adjustment, secured to it using the screws provided.

11.4 Floor boards are cut to suit the support plate up-stand and fixed to the trimmers/joists, using screws, as normal.

Concrete floors

11.5 The gully is placed on a bed of mortar and its level/position adjusted as necessary.

11.6 To help keep it in place during concrete pour, the gully is tied to the reinforcement using the lugs provided on its body (see Figure 3).

Figure 3 Installation in concrete floors

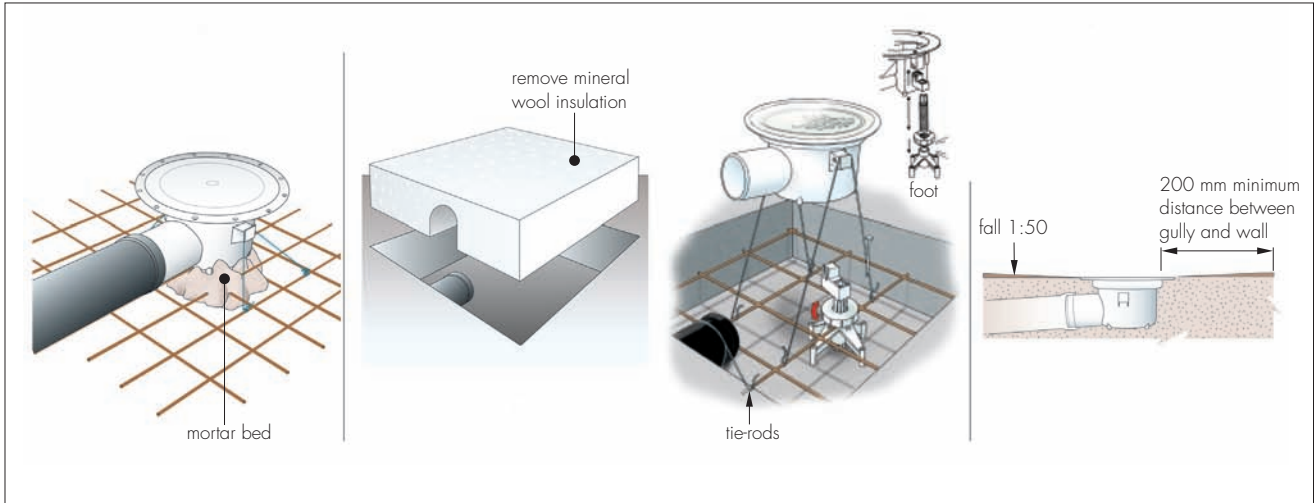

11.7 If the outlet pipe is installed first, a recess in the floor slab is made. The gully is then connected to the pipe end and concrete poured in the recess as normal (see Figure 3).

11.8 To facilitate level adjustment, a specially designed adjustable foot can be used (see Figure 3).

Vinyl/rubber floor coverings

11.9 Special clamping rings allow the floor covering to be attached around the gully (see Figure 4).

Figure 4 Installation with vinyl/rubber floor coverings

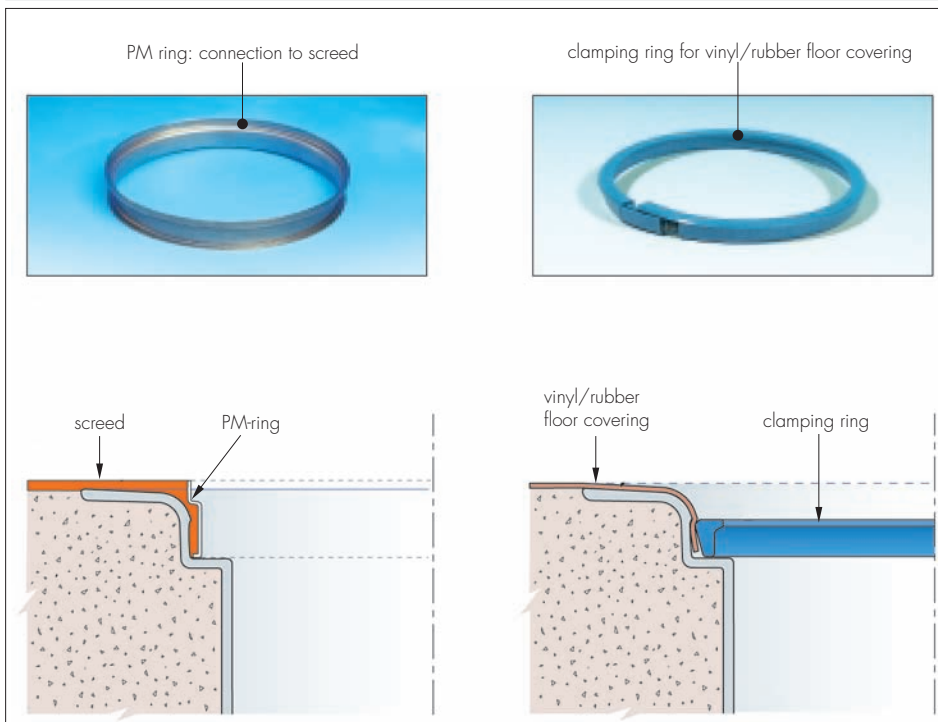

Additional Information

The management systems of Purus AB have been assessed and registered as meeting the requirements of EN ISO 9001 : 2000 by SP Certification accredited by the Swedish Board for Accreditation and Conformity Assessment (Certificate 1590).

Technical Investigations

12 Investigations

12.1 Based on the Swedish Technical Approvals and supporting data, and in accordance with the requirements of BS EN 1253-1 : 2003 and BS EN 1253-2 : 2003 and BS EN 274-1 : 2002, the products were assessed for:

- mechanical strength
- depth of water seal
- resistance of water seal to pressure
- blockage prevention
- position of side inlets
- odour and watertightness
- flow characteristics
- safety in use
- practicability of installation
- ease of maintenance
- resistance to thermal actions
- resistance to corrosion and chemicals.

12.2 The quality control procedures were examined and confirmation of the continuing surveillance by an inspection body, on behalf of SITAC, was obtained.

12.3 The manufacturer's literature was examined for any inconsistencies and general content.

Bibliography

BS 8102 : 1990 *Code of practice for protection of structures against water from the ground*

BS 8215 : 1991 *Code of practice for design and installation of damp-proof courses in masonry construction*

CP 102 : 1973 *Code of practice for protection of buildings against water from the ground*

BS EN 274-1 : 2002 *Waste fitting for sanitary appliances — Requirements*

BS EN 1253-1 : 2003 *Gullies for buildings — Requirements*

BS EN 1253-2 : 2003 *Gullies for buildings — Test methods*

BS EN 12056-1 : 2000 *Gravity Drainage Systems inside Buildings — General and performance requirements*

BS EN 12056-2 : 2000 *Gravity Drainage Systems inside Buildings — Sanitary pipework, layout and calculation*

BS EN 12056-3 : 2000 *Gravity Drainage Systems inside Buildings — Roof drainage, layout and calculation*

BS EN 12056-5 : 2000 *Gravity Drainage Systems inside Buildings — Installation and testing, instructions for operation, maintenance and use*

EN ISO 9001 : 2000 *Quality management systems — Requirements*

13 Conditions

13.1 This Certificate:

- relates only to the product/system that is named and described on the front page
- is granted only to the company, firm or person named on the front page — no other company, firm or person may hold or claim any entitlement to this Certificate
- is valid only within the UK
- has to be read, considered and used as a whole document — it may be misleading and will be incomplete to be selective
- is copyright of the BBA
- is subject to English law.

13.2 Publications and documents referred to in this Certificate are those that the BBA deems to be relevant at the date of issue or re-issue of this Certificate and include any: Act of Parliament; Statutory Instrument; Directive; Regulation; British, European or International Standard; Code of Practice; manufacturers' instructions; or any other publication or document similar or related to the aforementioned.

13.3 This Certificate will remain valid for an unlimited period provided that the product/system and the manufacture and/or fabrication including all related and relevant processes thereof:

- are maintained at or above the levels which have been assessed and found to be satisfactory by the BBA
- remain covered by a valid Swedish Agrément; and
- are reviewed by the BBA as and when it considers appropriate.

13.4 In granting this Certificate, the BBA is not responsible for:

- the presence or absence of any patent, intellectual property or similar rights subsisting in the product/system or any other product/system
- the right of the Certificate holder to manufacture, supply, install, maintain or market the product/system
- individual installations of the product/system, including the nature, design, methods and workmanship of or related to the installation
- the actual works in which the product/system is installed, used and maintained, including the nature, design, methods and workmanship of such works.

13.5 Any information relating to the manufacture, supply, installation, use and maintenance of this product/system which is contained or referred to in this Certificate is the minimum required to be met when the product/system is manufactured, supplied, installed, used and maintained. It does not purport in any way to restate the requirements of the Health & Safety at Work etc Act 1974, or of any other statutory, common law or other duty which may exist at the date of this Certificate; nor is conformity with such information to be taken as satisfying the requirements of the 1974 Act or of any statutory, common law or other duty of care. In granting this Certificate, the BBA does not accept responsibility to any person or body for any loss or damage, including personal injury, arising as a direct or indirect result of the manufacture, supply, installation, use and maintenance of this product/system.

