



Torre Puig, Barcelona, bonded with Sikasil® SG-550 and Sikasil® IG-25 HM Plus

SIKA FFI HIGH-STRENGTH GLASS BONDING

BUILDING TRUST



Sikasil® SG-550

Sikasil® IG-25 HM Plus

SINCE THE BEGINNING OF STRUCTURAL GLAZING, for most of the silicone adhesives, the design strength has been fixed at 0.14 N/mm². This started to change in 2006 when the design strength of Sikasil® SG-20 was rated with 0.17 N/mm².

Now Sika presents two innovations with a mechanical strength outperforming existing insulating glass and structural glazing silicone adhesives. In the latest ETA approvals issued in November 2011, the IG secondary edge seal Sikasil® IG-25 HM Plus has been evaluated with 0.19 N/mm². The structural glazing adhesive Sikasil® SG-550 is even rated with unmatched 0.20 N/mm². With 90% elongation at break, it can accommodate high movements in the SG modules.

Sikasil® SG-500 and Sikasil® IG-25

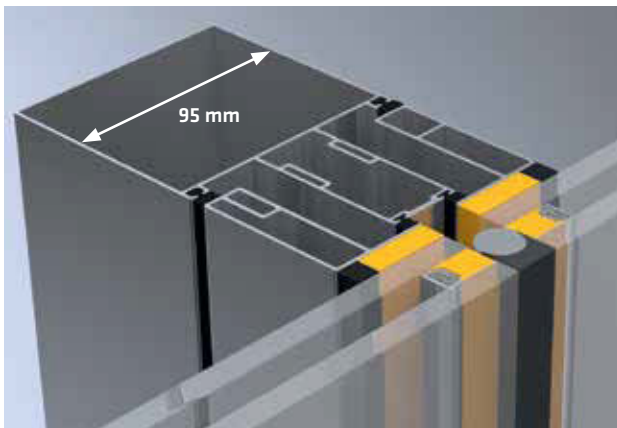

Joint sizes with standard silicone products

IG sealant dimension	17* 12 mm
SG joint dimension	30* 9.5 mm
Size of spacer type	9* 9.5 mm
Width of mullion	95 mm

Sikasil® SG-550 and Sikasil® IG-25 HM Plus

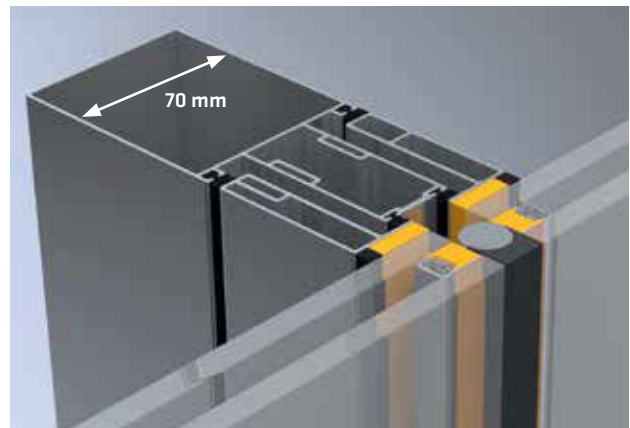

Minimised dimensions of IG seal height, SG joint, spacer tape and aspect of aluminum profile

IG sealant dimension	13* 12 mm
SG joint dimension	21* 6.4 mm
Size of spacer type	6* 6.4 mm
Width of mullion	70 mm

MATERIAL SAVINGS IN ALL DETAILS

The higher strength of the adhesives has an enormous saving impact on the material consumptions.

For a project with a wind load of 5 kPa and glass dimensions of 1.6 x 3.5 m, the following savings can be reached:

SG joint	60%
IG joint	23%
Spacer tape	55%
Aluminum	~8%

More details and sizes are visualised in the drawings above.

LET THE SUN SHINE IN

Modern architecture is light and transparent. It requests filigree frames in light weight aluminum constructions for large airport and sports hall facades or wide-spanning glass roofs.

In the sample above the aluminum, aspects have been reduced by 25%. The slimmer the frames the more transparent is the facade, the higher is the solar heat gain.

Sustainability all-over!

LOWEST ARGON LOSS RATES WITH Sikasil® IG-25 HM Plus

Argon-filled IG units have not been used in SG facades for many years. Hence structural facades were supposed to be banned for colder climates, due to ever stricter energy saving regulations. With the development of the high-modulus IG secondary edge seal Sikasil® IG-25 HM Plus, the glass panes in IG units are very tightly held together. Movements in the butyl layers, caused by temperature and pressure changes, are minimised. As a consequence, leakages in the butyl primary seal, the main barriers against argon penetration, are prevented. In tests complying with the European IG standard EN 1279-3, the best test units have proven an annual argon loss rate as low as 0.3%. The maximal limit in the standard is set with 1% per year.

ENERGY SAVING FOR MORE THAN 30 YEARS

With the argon loss rate of 0.5% per year, in average achieved at the European IG tests, after 30 years there is still an argon content of 80% to be expected in the IG cavity. Even after 30 years, the energy transfer coefficient of IG unit (U-value) has only increased by less than 0.1 W/m²K. This means that for the whole service life of a glass facade the high energy performance of the argon-filled insulating glass units remains almost unchanged. Sustainability all-over!

COMPARISON OF STRESS-STRAIN CURVE AND DESIGN STRENGTH

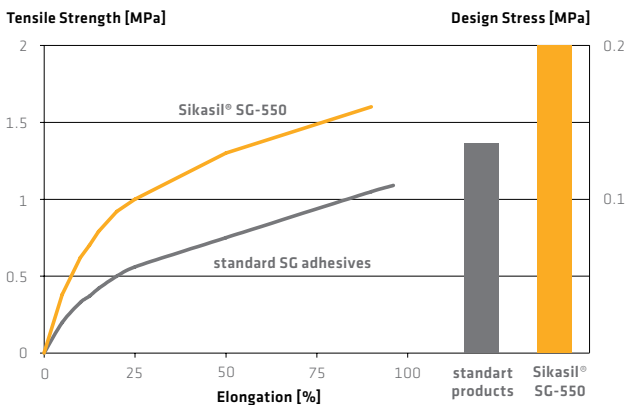

Fig. 1: Comparison of stress-strain curve and design strength of Sikasil® SG-550 with standard SG adhesives such as Sikasil® SG-500 and Sikasil®-IG-25

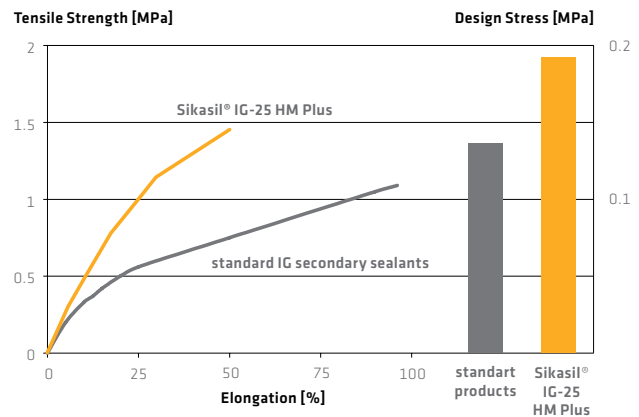

Fig. 2: Comparison of stress-strain curve and design strength of Sikasil® IG-25 HM Plus with standard IG products such as Sikasil® IG-25 HM Plus and most competitors products

Sikasil® SG-550

- Two-part structural glazing silicone adhesive
- Good processing properties on hydraulic pump systems, e.g. Reinhard Technik Ecostar 250, Lisec TAL 50 and TAL 60, TSI Mastermix XL and XS, DOPAG VISCO-MIX H200; pneumatic pumps must be tested individually.
- Excellent weathering and UV resistance
- Complies with ASTM C1184, ASTM C920, class 12.5, ETAG 002 and EN 15434, ETA approved (ETA 11/0392) and CE-marked

- Extremely high mechanical strength
Tensile strength: 1.6 N/mm²
Design tensile strength σ_{dyn} : 0.20 N/mm²
Design shear strength τ_{stat} : 0.013 N/mm²

Sikasil® IG-25 HM Plus

- Two-part silicone secondary edge seal for air- and argon-filled IG units in SG facades
- Outstanding processing properties (dosing and tooling)
- Excellent weathering and UV resistance
- Complies with ETAG 002 and EN 13022, ETA approved (ETA 11/0391) and CE-marked for black and grey

- Extremely high mechanical strength
Tensile strength: 1.4 N/mm²
Design tensile strength σ_{dyn} : 0.19 N/mm²
Design shear strength τ_{stat} : 0.011 N/mm²

GLOBAL BUT LOCAL PARTNERSHIP



FOR MORE INFORMATION:

For more literature about Sika Facade and Fenestration solutions browse:

www.sika.com/ffi-downloads

WHO WE ARE

Sika is a specialty chemicals company with a leading position in the development and production of systems and products for bonding, sealing, damping, reinforcing and protecting in the building sector and the motor vehicle industry. Sika has subsidiaries in 90 countries around the world and manufactures in over 160 factories. Its more than 17,000 employees generate annual sales of CHF 5.6 billion.

Technical Service

Sika Services AG
FFI Competence Centre
Tüffenwies 16
CH-8048 Zürich
Phone +41 58 436 5633
Fax +41 58 436 5407
it-ses-admin@it.sika.com

Customer Service

Sika Engineering Silicones Srl.
Via L. Einaudi, 6
I-20068 Peschiera Borromeo (MI)
Phone +39 02 516591 205
Fax +39 02 516591 298
it-ses-admin@it.sika.com

Our most current General Sales Conditions shall apply.
Please consult the Data Sheet prior to any use and processing.



SIKA SERVICES AG

Tueffenwies 16
8048 Zurich
Switzerland



www.sika.com/ses

Front Cover

Torre Puig, L'Hospitalet de Llobregat,
Barcelona
Architect: José Rafael Moneo
Facade by: Permasteelisa, Spain
Products used:
Sikasil® SG-550
Sikasil® IG-25 HM Plus
Sikasil® WS-605 S

BUILDING TRUST

