

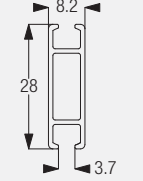







Room Divider/Cubicle/ Shower Rail Systems

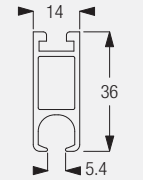

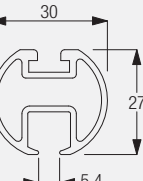

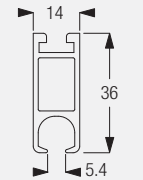
Application Chart

Specification	Profile				Features / Options		Fitting Options			Fitting Surfaces			System		
	Weight Range	Profile Number	Dimensions in mm		Gliding Channel (mm)	Standard Bending Radius (mm)	Safety Device Option	Shower Rail only	Ceiling Fix	Wall Fix	Fitting with Hanger Rods	Wood		Concrete	Suspended ceiling
 kg	1085		3.7	200			●		●	●	●	●	●	●	1085
 kg	6101		5.4	200				●	●	●	●	●	●	●	6100
 kg	6103		5.4	300				●	●	●	●	●	●	●	6103
 kg	6101		5.4	300			●		●	●	●	●	●	●	6650

 Sliding panel systems can also be used for room dividing. Please refer to the Sliding Panel Systems section of the catalogue for further information.

 Light-weight applications

 Medium-weight applications

 Heavy-duty applications

Standard shapes and sizes as shower rail (1085/6100 and 6103 Systems)

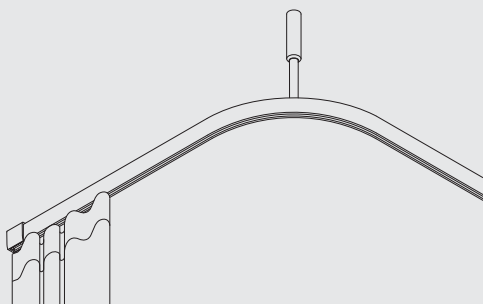

6100/6103 can also be custom shaped for special baths.
Both are available in silver anodised finish.
6103 is also available in chrome and anodised gold finished.

Model A

91cm, 183cm, 213cm, 244cm



Model B

76cm x 76cm, 91cm x 91cm



Model C – left

Model D – right
168cm x 76cm



Model E

91cm x 76cm x 91cm

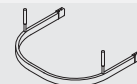

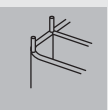

Shower Rail System

Silent Gliss® 1085

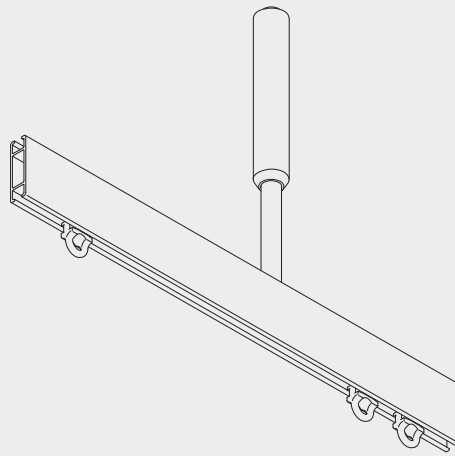

Product Information

- For use as a shower rail only, not suitable for room divider/cubicle
- Attractive reversible rail with varied fixing possibilities
- For medium weight curtains
- Wide application for showers
- Available as a shower rail in kits
- Satin silver anodised finish only
- 4m lengths only



1085

Profile, Bending and Specification Information

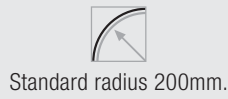
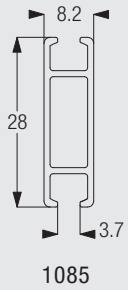

The standard radius is recommended for optimal operation. The minimum possible radius is 150mm.

Specification Guide - download from www.silentgliss.co.uk (password required).

Silent Gliss 1085 room divider system, anodised aluminium rail type 1085, secured to fittings detailed as follows. Allow for noggins in suspended ceiling / hollow partitions elsewhere in B of Q. Pre-forming bend in running length 90/135 degrees. Nylon glider/hook 3533C fitted to track at 10/ metre. Nylon wall support 3652 screwed/plugged and screwed to wall and fitted to track using endstop 3017. 3610S hanger rod system, anodised aluminium, drop m once screwed through ceiling to noggin above and secured to track with 3699 insert.

System Layout Options

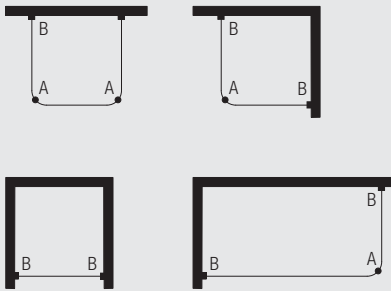

A: hanger rod 3610S
B: wall support 3652



For straight applications hanger rods are not necessary except for extra strength on lengths above 6'/183cm. For pre-packed kits, refer to application chart.

1085

Fitting Options

Ceiling fix with hanger rod 3610S

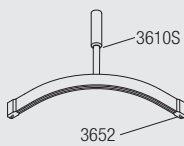
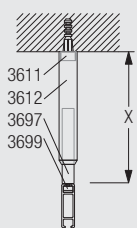

	X (m)
3610S	1.22

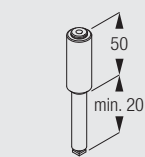

3610S
Hanger rod assembly

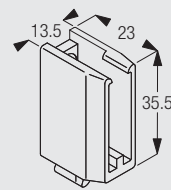

3652
Wall support

Wall fix with wall support 3652

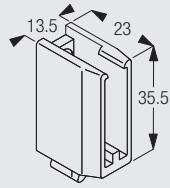
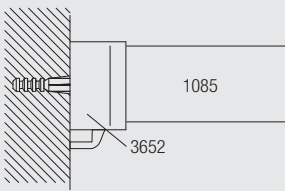





3652
Wall support

Standard Accessories

1085	Profile		3017	Endstop	
3652	Wall support		3533C	Glider with hook	

Standard Accessories - Sets

3610S	Hanger rod assembly		3697	Rod	1	
			3698	Washer	1	
			3611	Stud	1	
			3612	Support with screw	1	
			3699	Track insert	1	



1085

Optional Accessories

3070	Twist eye endstop		3071	Screw twist endstop	
3533	Glider		3534	Glider 3533 in strip form	
3570	Rotating glider		6146	Hook	

Useful Information

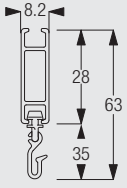

Diagram uses standard glider/hook combination 3533C. For glider 3570 the lower dimension will be 5.4mm.



1085

Room Divider/Cubicle/Shower Rail System

Silent Gliss® 6103

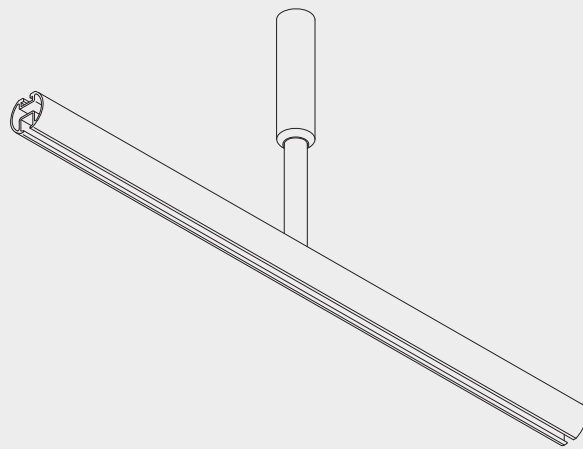

Product Information

- Attractive contemporary rounded profile shape whilst system enjoys all the flexibility and strength of the proven 6100 system
- Available as standard in silver and white. Gold and chrome available for shower rails only
- Special custom colouring facility for this profile and components enables specifiers to select a RAL colour to complement or contrast with decor
- Clean, unbroken line in hospital wards
- The top channel maximises connection positions and suspension variations. The dust-cover strip reduces the risk of cross-infection
- Standard length silver and white 6m, 7m and 7.5m (silver only), gold and chrome 4m
- Medium to heavy curtains
- Conforms to HTM66



6103

Profile, Bending and Specification Information

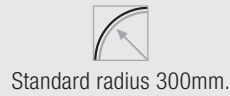
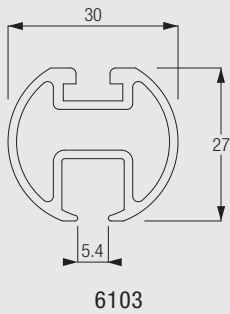

The standard bending radius is recommended for optimal performance. Minimum bending radius for 6103 is 200mm.

Specification Guide - download from www.silentgliss.co.uk (password required).

Silent Gliss 6103 room divider system, anodised aluminium rail 6103/powder coated aluminium rail 6103 in(colour), secured to fittings detailed below. Allow for noggins in suspended ceiling/hollow partitions elsewhere in B of Q.

Pre-forming bend in running length 90/135 degrees.

Dust cover 6110 fitted to track.

Nylon glider/hook 6147 fitted to track at 10/metre.

Nylon wall support 6620 twice screwed/plugged to wall and fitted to track.

Wall bracket 6503/anodised aluminiummm wide by projectionmm, each bracket screwed/plugged to wall and fitted to track.

Nylon end cover 6630 secured to track.

End stop 6007 secured to track.

Connecting bridge 6512, anodised aluminium secured to track.

T-junction 6514M, anodised aluminium secured to track.

T-junction 6525, anodised aluminium secured to track.

Ceiling fixing plate 6138, anodised aluminium once screwed through ceiling to noggin above/plugged and screwed and secured to track.

Twist fixing plate 6124 twice screwed/plugged to ceiling and secured to track.

6190 Hanger, anodised aluminium assembly dropm once screwed through ceiling to noggin above (noggin by others)/plugged and screwed and secured to track.

6501 V-hanger, anodised aluminium assembly dropm twice screwed through ceiling noggins above (noggins by others)/plugged and screwed and secured to track.



6103

System Layout Options

As a universal room divider/shower rail system with various accessories, there are few limits to size and layouts.

Typical layout for hospital (without V-hangers)

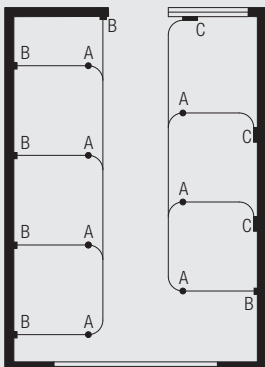

A: hanger rod 6190
B: wall support 6620
C: bracket 6503

Typical method obtaining stability by attaching cubicles to corridor (or window) wall.

Typical layout for hospital (with use of V-hangers)

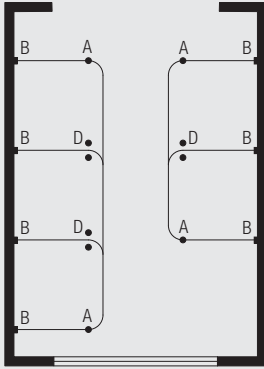

A: hanger rod 6190
 B: wall support 6609
 D: V-hanger 6501

Lateral stability in any cubicle layouts is essential to prevent weakening of the wall and ceiling fixtures by lateral movement. Where it is not practical to fit tie bars, etc., stability may be obtained by the incorporation of V-hangers to the ceiling as shown in the diagram above.

Fitting Information

The System 6103 is normally ceiling and wall fixed on suspended hangers and special wall brackets.

Site preparation for suspended ceiling applications

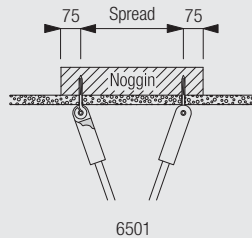
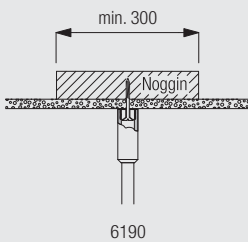

Fixings should support the ends of the profile and any changes in direction. Maximum span between fixings is 300mm. When fitting to suspended ceilings site preparation is critical. At each hanger position a noggin in approved material is required above the suspended ceiling; underside to rest on top of ceiling (but independently supported) with a minimum length of 300mm at right angles to the track in which the hanger occurs to give fixing tolerance. Ideally the hangers should be on the return track, if on the front track then adequate support should be provided. A detailed information sheet is available on request.



6103

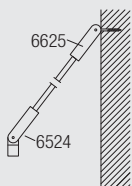

Diagonal fixing supports can be used to return the hanger to the bedhead wall, but only for use when it is impossible to ceiling fix.

Dust Cover Strip

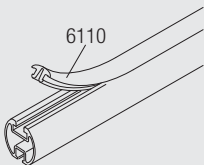

Dust cover strip 6110 for profile 6103 reduces the risk of infection.

Fitting Options

Ceiling fix with fixing plate

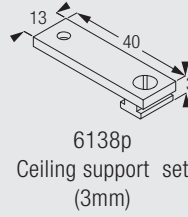
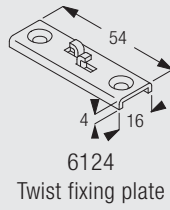
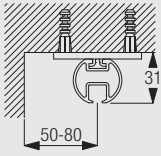

Fixing plate positioning is recommended to be at maximum 300mm intervals.

Ceiling fix with ceiling support 6175

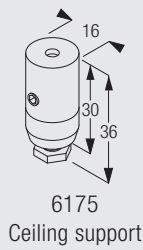
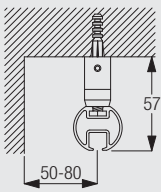

Bracket positioning is recommended to be at maximum 300mm intervals.

Ceiling fix with hanger 6190

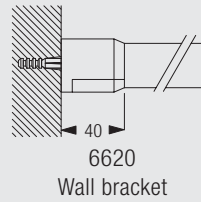
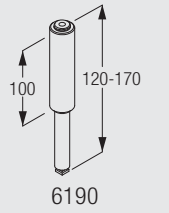
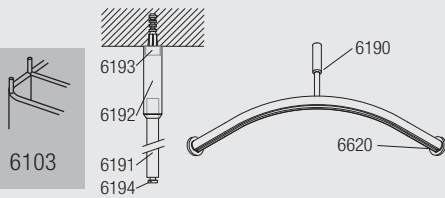

Can also be fixed through suspended ceilings by using special sleeves 6197, 6187, 6188.

Ceiling fix with V-hanger 6501

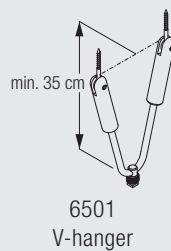
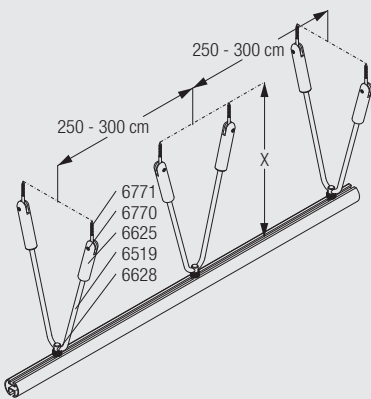

Wall fix with bracket 6503

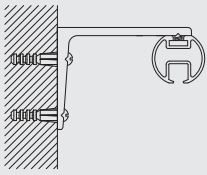

	mm		mm	
6503a	25x50	6503b	50x50	
6503c	50x100	6503d	100x50	
6503e	200x50	6503f	100x100	
6503g	75x150			

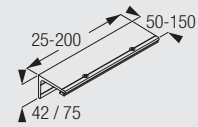

6503
Wall bracket (various sizes)

Wall fix with special wall support 0550A for traditional shower rail

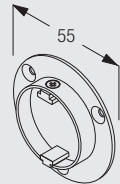
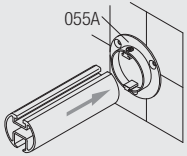



0550A
Special support
(chrome and gold only)

Standard Accessories

3582	Hook		0550A	Special support (chrome and gold only)	
6007	Endstop		6065	Twist eye endstop	
6086	Spring stop		6094	Roller glider with hook	
6096	Glider 6083 in strip form		6098	Roller glider with eye	
6103	Profile		6110	Dust cover	
6124	Twist fixing plate		6143	Glider 6144 in strip form	
6146	Hook		6147	Glider 6144 with hook 6146 in strip form	
6175	Ceiling support		6283	Roller glider	
6503	Wall bracket (various sizes)		6514	T-Junction	
6521	External bridge		6525	Cross connection	
6620	Wall bracket		6630	Endcover (ø32.5mm)	

6103

6631 Connecting piece 

6138p Ceiling support set (3mm) 

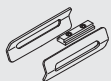
6635 Internal connecting bridge assembly 

Sets

6190 Hanger rod assembly

6194 Track insert

1



6191 Hanger rod

1

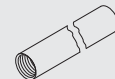

6192 Sleeve

1



6193 Ceiling stud

1



6501 V-hanger assembly

6625 Complete fixing sleeve

1



6770 Locking pin

1



6771 Vine eye

1



6519 Hanger rod

1



6628 V-hanger track insert

1



6103

Optional Accessories

6160 Connecting piece



6187 Dummy ceiling support sleeve



6188 Ceiling support



6197 Hanger joint sleeve



6524 Diagonal fixing support



6625 Complete fixing sleeve



Useful Information

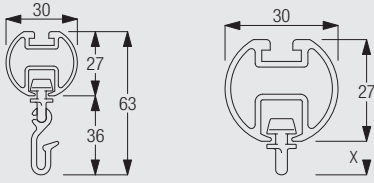

The left hand diagram illustrates the standard measurements for 6103 cubicle/shower system with combined 6147 glider/hook. For non-medical application refer to the right hand illustration and the figures below for the roller/glider dimensions.

- 6083 = 7mm
- 6094 = 31mm
- 6098 = 26mm
- 6283 = 7mm
- 6144 = 9mm



6103



6103

Room Divider/Cubicle/Shower Rail System

Silent Gliss® 6100

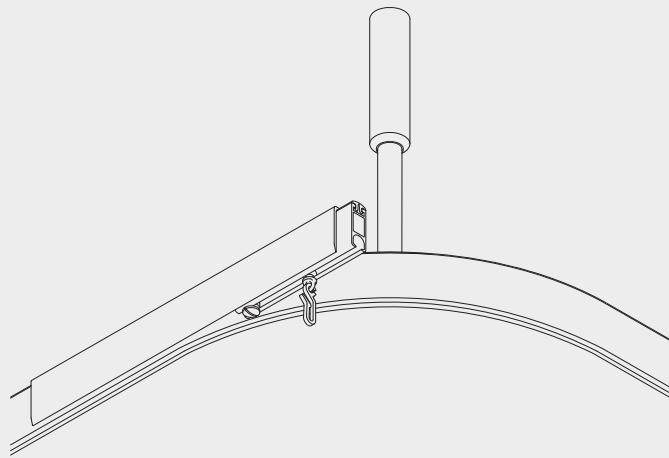

Product Information

- For over 40 years the most widely used hospital cubicle system in the world
- Also used for many varied industrial and commercial applications
- Attractive profile combines mechanical strength and flexibility with the smoothest performance
- The design detail gives rigidity and strength with great flexibility in layout whilst achieving a clean unbroken line in hospital wards
- The top channel maximises connection positions and suspension variations. The dust cover strip reduces the risk of cross infection
- Quick release safety device is available through distributors for high risk areas, (see System 6650)
- Stand colour silver. Also available in white
- Standard lengths 6101 in metres: 4.5m, 4.75m, 5.0m, 5.25m, 5.5m, 6.0m, 6.75m, 7.5m (silver only). Profile connector available
- For medium to heavy curtains
- An exclusive network of skilled distributors measure, supply and fix all hospital contracts in the U.K. and Eire
- Conforms to HTM66
- White profile incorporates BioCote anti-microbial coating as standard



6100

Profile, Bending and Specification Information

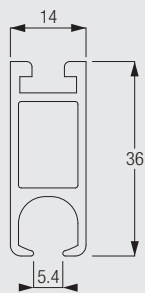

6101



Standard radius 200mm.

The standard radius is recommended for optimal operation. The minimum possible radius is 150mm.

6109 An alternative profile to be used for reversible shower rails or uplighter systems (available through distributors).

Specification Guide - download from www.silentgliss.co.uk (password required).

Silent Gliss 6100 cubicle track system, anodised aluminium rail type 6101, secured to fittings detailed below by approved local distributor. Allow for noggins in suspended ceiling/hollow partitions elsewhere in B of Q.

Pre-forming bend in running length 90/135 degrees.

Dust cover 6110 fitted to track.

Nylon glider/hook 6147 fitted to track at 10/metre.

Delrin wall support 6609 twice screwed/plugged to wall and fitted to track.

Wall bracket 6503/anodised aluminium 50mm wide (two per set), each bracket screwed/plugged to wall and fitted to track.

Delrin end cover 6611 secured to track.

End stop 6007 secured to track.

Connecting bridge 6512, anodised aluminium secured to track.

T-junction 6514, anodised aluminium secured to track.

Double T-junction 6525, anodised aluminium secured to track.

Internal connecting bridge secured to track.

Ceiling fixing plate 6137, anodised aluminium (single), once screwed through ceiling to noggin above (noggin by others)/plugged and screwed and secured to track.

Double ceiling fixing plate 6138, anodised aluminium twice screwed through ceiling to noggin above (noggin by others)/plugged and screwed and secured to track.

6190 Hanger, anodised aluminium assembly drop m once screwed through ceiling to noggin above (noggin by others)/plugged and screwed and secured to track.

6501 V-hanger, anodised aluminium assembly drop m twice screwed through ceiling noggins (noggins by others)/plugged and screwed and secured to track.



6100

System Layout Options

As a universal room divider system with various accessories, there are few limits to size and layouts. The recommended height from floor level to the underside of the track is 2100mm.

Typical layout for hospital (without V-hangers)

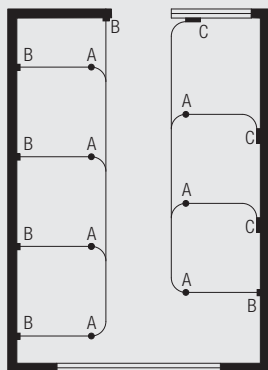

A: hanger rod 6190

B: wall support 6609

C: bracket 6503

Typical layout for hospital (with use of V-hangers)

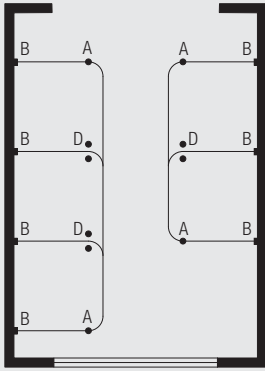

A: hanger rod 6190
 B: wall support 6609
 D: V-hanger 6501

Lateral stability in any cubicle layout is essential to prevent weakening of the wall and ceiling fixtures by lateral movement. Where it is not practical to fit tie bars etc., stability may be obtained by the incorporation of V hangers to the ceiling as shown in the diagram above.

Fitting Information

The System 6100 is normally ceiling and wall fixed on suspended hangers and special wall brackets.

Site preparation for suspended ceiling applications

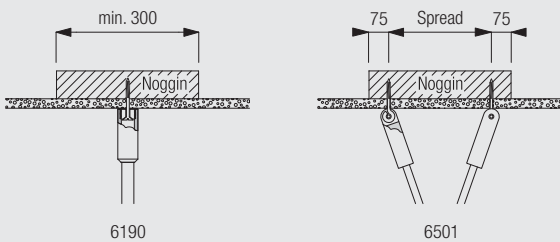

Fixings should support the ends of the profile and any changes in direction. Maximum span between fixings is 3000mm. When fitting to suspended ceilings site preparation is critical. At each hanger position a noggin in approved material is required above the suspended ceiling; underside to rest on top of ceiling (but independently supported) with a minimum length of 300mm at right angles to the track in which the hanger occurs to give fixing tolerance. Ideally the hangers should be on the return track, if on the front track then adequate support should be provided. A detailed information sheet is available on request.



6100

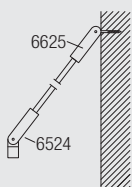

Diagonal fixing supports can be used to return the hanger to the bedhead wall, but only for use when it is impossible to ceiling fix.

Dust Cover Strip

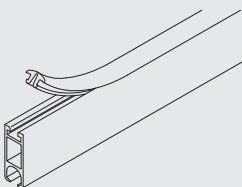

Dust cover strip 6110 for profile 6101 (6108 for profile 6109), it reduces the risk of cross infection.

Fitting Options

Ceiling fix with fixing plates

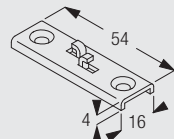
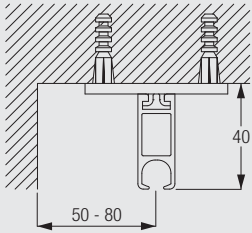

6124
Twist fixing plate

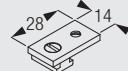

6137
Ceiling fix bracket



6138
Ceiling fix bracket
double (42mm)

Fixing plate positioning is recommended at maximum 300mm intervals.

Ceiling fix with ceiling support 6175

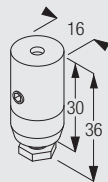
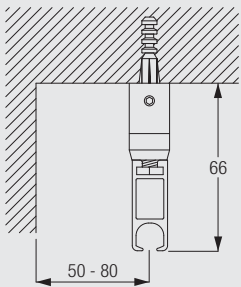

6175
Ceiling support

Bracket positioning is recommended at maximum 300mm intervals.

Ceiling fix with hanger rod 6190



6100

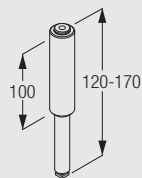
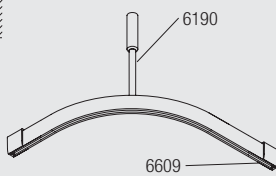
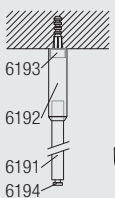

6190
Hanger rod assembly

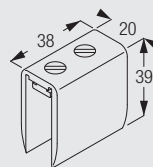

6609
Wall support

Can also be fixed through suspended ceilings by using special sleeves 6197, 6187, 6188

Ceiling fix with V-hanger 6501

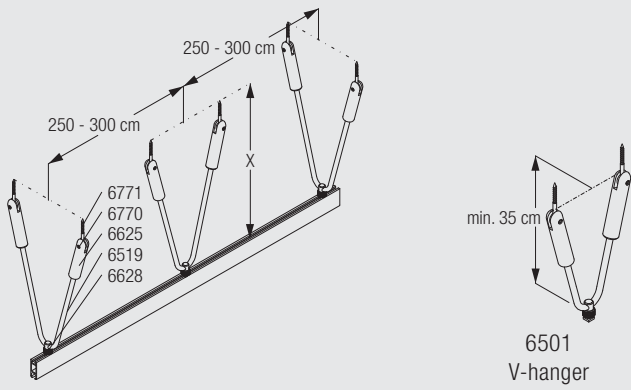

Lateral stability in any cubicle layout is essential to prevent weakening of the wall and ceiling fixtures by lateral movement. V-hangers (25°-35°) provide alternative lateral stability when not practical to fit tie bars and to stabilise straight track over 3 metres.

Wall fix at 90° to wall

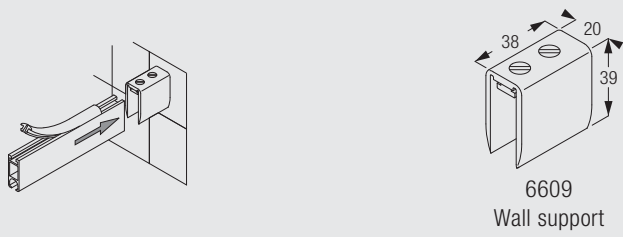

Profile Junctions (join lengths at 90°)

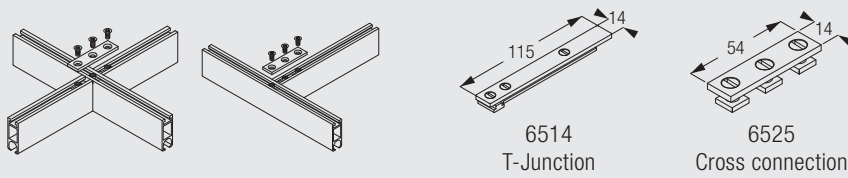

Profile Connecting bridge 6512 (bent applications)

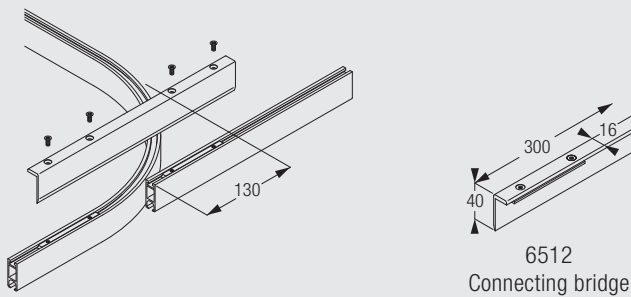

6100

Wall fix with bracket 6503(a-g)

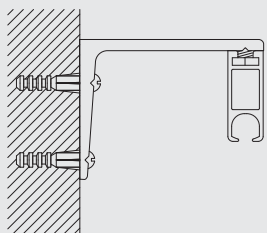

	(mm)	(mm)
6503a	50x50	6503b 200x50
6503c	50x100	6503d 100x50
6503e	25x50	6503f 100x100
6503g	75x150	

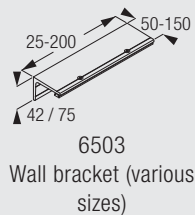

Standard Accessories

6007 Endstop



6065 Twist eye endstop



6083 Glider



6086 Spring stop



6094 Roller glider with hook



6096 Glider 6083 in strip form



6098 Roller glider with eye



6101 Profile



6110 Dust cover



6124 Twist fixing plate



6137 Ceiling fix bracket



6138 Ceiling fix bracket double (42mm)



6143 Glider 6144 in strip form



6146 Hook



6147 Glider 6144 with hook 6146 in strip form



6175 Ceiling support



6187 Dummy ceiling support sleeve



6199 Internal connecting bridge

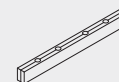

6503 Wall bracket (various sizes)

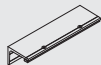

6512 Connecting bridge

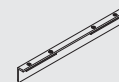

6514 T-Junction



6525 Cross connection

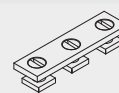

6609 Wall support



6611 Endcover



6628 V-hanger track insert



Sets

6190 Hanger rod assembly

6194 Track insert

1



		6191	Hanger rod	1	
		6192	Sleeve	1	
		6193	Ceiling stud	1	
6501	V-hanger assembly	6771	Vine eye	1	
		6770	Locking pin	1	
		6625	Complete fixing sleeve	1	
		6519	Hanger rod	1	
		6628	V-hanger track insert	1	

Optional Accessories

Parts

6108	Dustcover for 6109		6109	Profile	
6160	Connecting piece		6188	Ceiling support	
6197	Hanger joint sleeve		6283	Roller glider	
6524	Diagonal fixing support				



6100

Useful Information

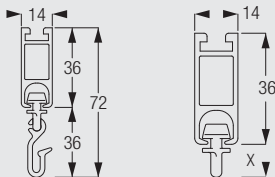

The left hand diagram illustrates the standard measurements for 6100 cubicle/shower system with combined 6147 glider/hook. For non medical application refer to the right hand illustration and the figures below for the roller glider dimensions.

- 6083 = 7mm
- 6094 = 31mm
- 6098 = 26mm
- 6283 = 7mm
- 6144 = 9mm



6100

Room Divider/Cubicle/Shower Rail System

Silent Gliss® 6650 Safety Device

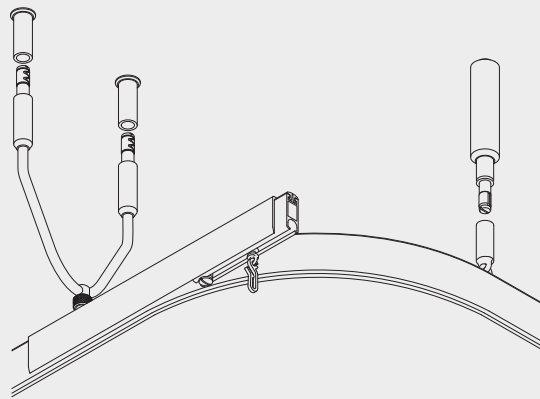

Product Information

- The 6650 Safety Device System has been designed for specific use in high risk areas to reduce the opportunity for self-harm. The precision-engineered pull-out ensures that the device will remain in place during normal everyday use
- The 6650 has been developed to work exclusively with Silent Gliss 6101 Cubicle Track and is complete with single hangers, V-hanger for lateral stability, wall supports and wall bracket systems (patent pending), thereby covering the vast majority of layouts as well as for fast and simple retrofitting of existing layouts
- Neat, strong system designed around the proven existing 6101 track
- Single hanger incorporates a friction-based joint (patent pending) which will progressively separate within a stated maximum load
- Designed with maximum protection from wear and tear to minimise inspection and future replacement
- Separation of single hanger is at track level for easy replacement
- Progressive separation of the 6651 acts as a warning and reduces incidences of separation through over heavy handling of curtains, etc
- The inclusion of the friction-based joint also in the V-hanger for lateral stability means that a safe environment is achievable without compromising layout design. The V-hanger has been specifically designed to separate under the same maximum load as the single hanger 6651
- The unique wall support (patent pending) is designed to take lateral and vertical downward pressure without causing damage to the support
- The wall brackets allow bed returns, etc., to be included in the design to meet layout specifications
- A detachable connecting bridge reduces the risk of the domino effect where one collapsing cubicle brings down attached systems



6650

Profile and Bending Information

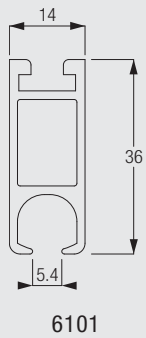

The standard radius is recommended for optimal operation. The minimum possible radius is 150mm.

The 6650 safety device system is designed for specific use with the 6100 cubicle system with the 6101 profile option only, it is **not** for use with the 6109 profile option.

Safety Key Components

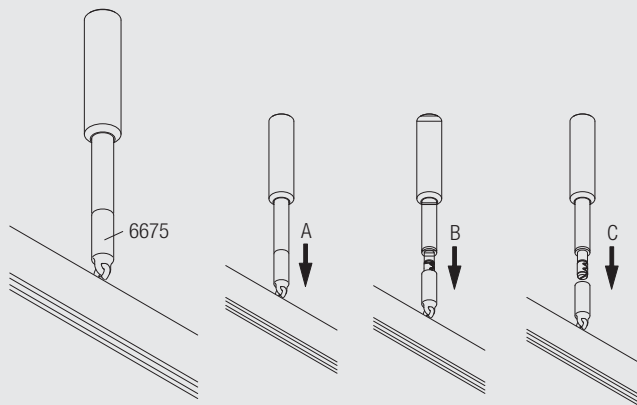

6675 safety device for single hanger
Pictured here in the process of separating (a,b) and separated (c).

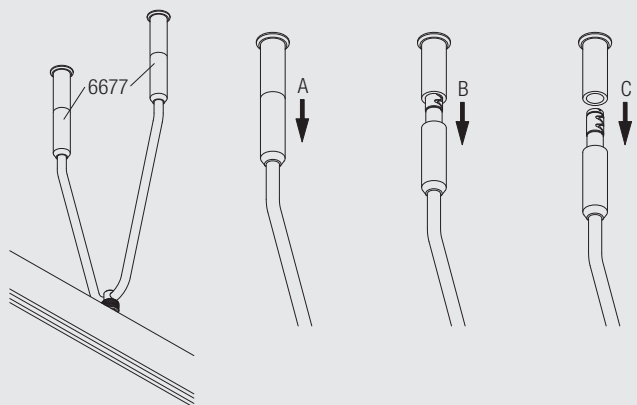

6677 safety device for V-hanger
Assembly pictured here in the process of separating (a, b) and separated (c)

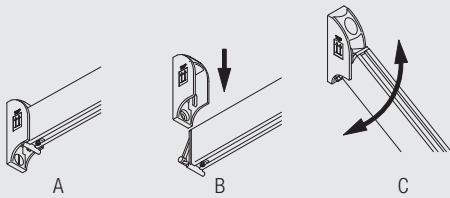

Wall support 6655 (for right angled fixing of the profile to the wall)
 Safety wall support 6655 is uniquely designed to ensure that the track will separate with a direct downward pressure or will tilt to minimise damage.

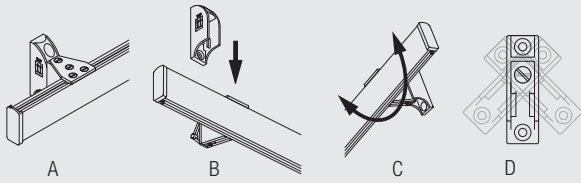

Wall bracket 6668 (for parallel fixing of the profile to the wall)
 Profile separates from wall support at given weight (A,B). The profile will pivot in the bracket (C,D).

Separation loads: The Silent Gliss Safety Device has been designed to separate when a maximum load of 40kg is applied at any point of the cubicle track.

System Layout Overview

Layout guide for 6650 safety device system

Typical Track Layout

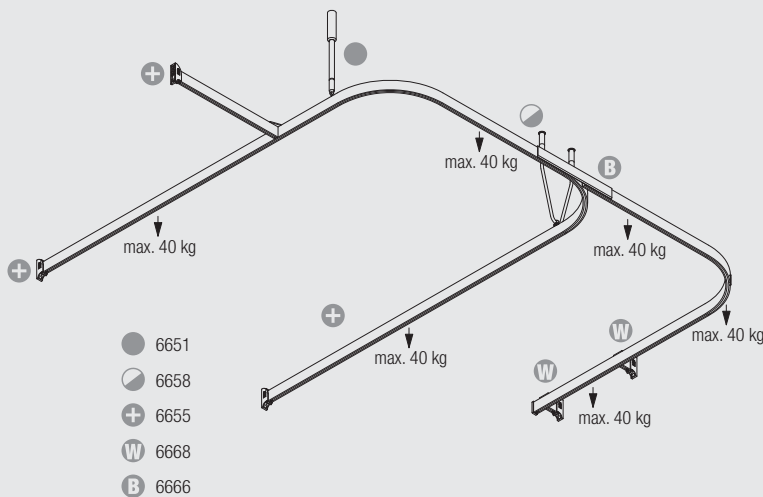

Straight Shower Rail

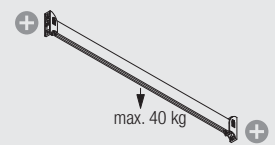

Bent Shower Rail/ /Door Screen

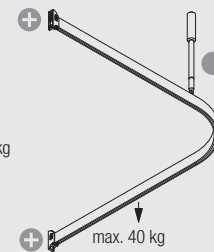

Room Dividers, Showers and Door Screens

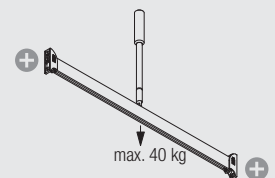

As universal room divider system with various accessories, there are almost no limits to size and layouts. The recommended height from finished floor level to the underside of track is 2100mm

Typical method of obtaining stability is by attaching the system to the corridor wall or window.

System Layout Options

Shower application corner and wall

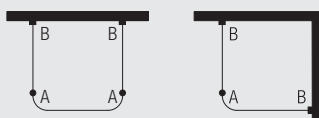

A: hanger rod 6651
 B: wall support 6655

Multiple bend application

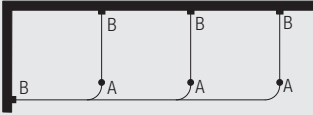

A: hanger rod 6651
B: wall support 6655

Multiple straight application

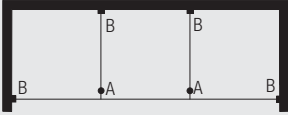

A: hanger rod 6651
B: wall support 6655

Typical layout for hospital (without V-hangers)

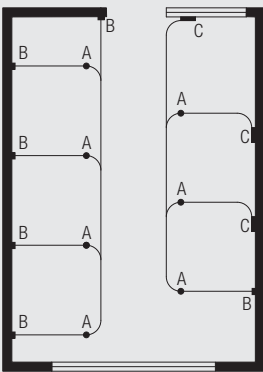

A: hanger rod 6651
B: wall support 6655
C: wall support 6668

Typical layout for hospital (with V-hangers)

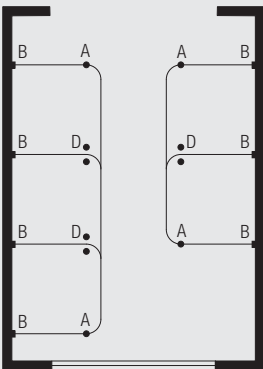
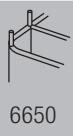

A: hanger rod 6651
B: wall support 6655
D: V-hanger 6658

Fitting Information

The Silent Gliss 6650 system is intended to reduce the risk of self-harm in cubicle situations. In order to work correctly it must be fitted in accordance with the specific 6650 fitting instructions. Failure to do so will reduce its effectiveness. Any queries or anomalies should be reported to Silent Gliss. If you require any information on quality management procedures please contact Silent Gliss.

Fixings should support ends of profile plus changes in direction. Maximum span between supports is 2.5m. The position of supports can affect the performance of the system. Please consult one of the Silent Gliss network of Specialist Distributors.

Site preparation for suspended ceiling applications

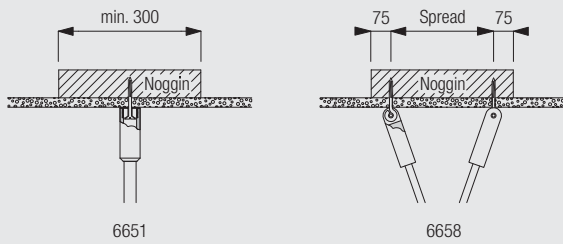

Fixings should support the ends of the profile and any changes in direction. Maximum span between fixings is 300mm.

When fitting to suspended ceilings site preparation is critical. At each hanger position a noggin in approved material is required above the suspended ceiling; underside to rest on top of ceiling (but independently supported) with a minimum length of 300mm at right angles to the track in which the hanger occurs to give fixing tolerance. Ideally the hangers should be on the return track, if on the front track then adequate support should be provided. A detailed information sheet is available on request.

Dust Cover Strip

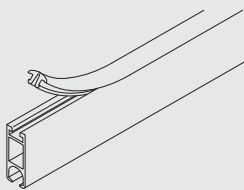

Dust cover strip 6110, reduces the risk of cross infection, (an application for a special patented dustcover - 0715 - reducing the risk of self harm for patients has been applied for).

Fitting Options

Ceiling fitting with hanger 6651

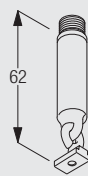
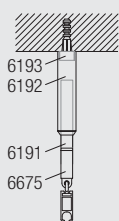

6675
Safety device for
vertical hanger



6650

Ceiling fitting with V-hanger 6658

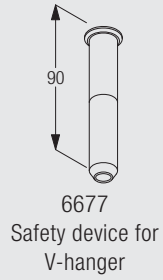
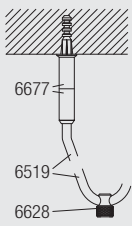

Wall fitting with support 6655 (for fixing of profile at right angles to wall)

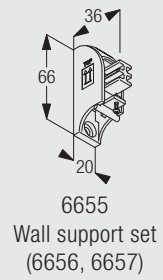
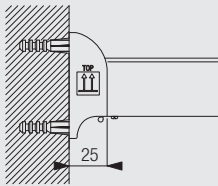

Wall fitting with support 6668 (for parallel fixing of profile to the wall)

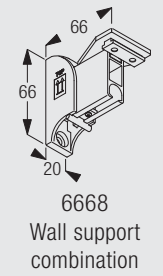
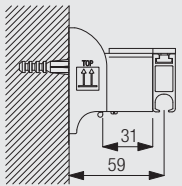

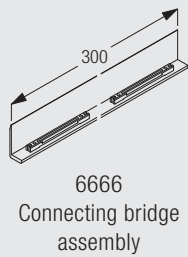
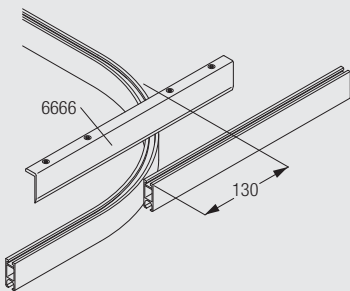

Profile connecting bridge 6666



Standard Accessories

0785	Acrylic disk	
------	--------------	---







6110	Dust cover	
------	------------	---

6101	Profile	
------	---------	---

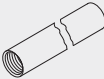
6147	Glider 6144 with hook 6146 in strip form	
------	--	---

6611	Endcover		6655	Wall support set (6656, 6657)	
6663	Wall bracket combination		6666	Connecting bridge assembly	
6668	Wall support combination		6671	Washer insert for countersunk screw	
6672	Screw cover for 6671		6675	Safety device for vertical hanger	
6677	Safety device for V-hanger				

Sets

6651	Hanger 6651 with safety device 6675		6191	Hanger rod	1	
			6192	Sleeve	1	
			6193	Ceiling stud	1	
			6675	Safety device for vertical hanger	1	
6658	V-hanger with safety device 6677		6519	Hanger rod	1	
			6628	V-hanger track insert	1	
			6677	Safety device for V-hanger	2	

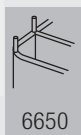

Useful Information

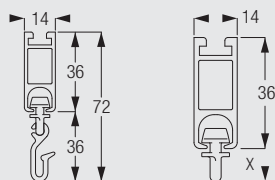

The left hand diagram illustrates the standard measurements for 6101 cubicle/shower system with combined 6147 glider/hook. For non-medical application refer to the right hand illustration and the figures below for the roller/glider dimensions.

- 6083 = 7mm
- 6094 = 31mm
- 6098 = 26mm
- 6283 = 7mm
- 6144 = 9mm



6650



6650



6650



6650

www.silentgliss.co.uk
www.silentglissglobal.com

Silent Gliss Ltd
Pyramid Business Park
Poorhole Lane
Broadstairs
Kent
CT10 2PT
Great Britain

Tel: +44 (0) 1843 863571
Fax: +44 (0) 1843 864503
info@silentgliss.co.uk

Silent Gliss Global Ltd
Pyramid Business Park
Poorhole Lane
Broadstairs
Kent
CT10 2PT
Great Britain

Tel: +44 (0) 1843 874250
Fax: +44 (0) 1843 874457
info@silentglissglobal.com