

Cubicle Express

**We know express washrooms.  
Your 48-hour dedicated service.**

**Venesta**

**We know express washrooms.  
We're passionate about setting  
new standards of design,  
performance and reliability.  
And now, we're delivering new  
levels of flexibility with the  
48-hour Cubicle Express range.**

At Venesta\*, we work hard to deliver product excellence. Ever since the early days, innovation has been a core feature of who we are and it's helped us to create a brand that customers can rely on to satisfy the most challenging of briefs.

Our constant need to innovate has now led us to create the ultimate washroom solution to meet your demands for a quick and easy washroom installation. Cubicle Express is a pioneering off-the-shelf solution, supplied to you within 48-hours.

Choosing the right Cubicle Express for you couldn't be easier. Simply use the handy guide at the back of this brochure, place your order and within 48-hours, your hassle-free washroom solution will be ready to install.

\*formerly Armitage Venesta



## The quickest and simplest installation is ready and waiting.

Promising you the winning combination of best value and uncompromising design quality, the Cubicle Express range includes cubicles, duct panels and vanities. All suitable for dry environments, the range features enlarged and ambulant cubicles with all the components and fixing instructions you need for a speedy build.

Available in oversized formats for onsite flexibility, Cubicle Express has a range of innovative features including channels that replace cleats and a new universal hinge. You can also choose from a selection of colours and shaped, low height doors, and have the option of our post-formed pilaster.



**Main image**  
Cubicle Express cubicles, duct panels and vanity in Graphite and Warm Oak

**01** UPVC wall channel and H-section

**02** Cubicle Express children's doors in Gala, with Graphite pilasters and partitions



# Technical Specifying Cubicle Express

## Dimensions

**Overall height**  
1950mm

**Floor clearance**  
150mm

**Maximum depth**  
1800mm

## Performance

Available in MFC, Cubicle Express is suitable for dry environments allowing you to specify with confidence.

### MFC

For dry environments with low risk of vandalism. Panels are manufactured from 18mm nominal thickness high performance moisture-resistant melamine faced chipboard. Edges lipped with PVC.

## Detailing

### Panels and doors

18mm nominal thickness melamine faced chipboard (MFC).

Post-formed pilaster option:  
18mm nominal overall thickness high pressure laminate (HPL) faced chipboard.

### Vanities

18mm nominal thickness high pressure laminate (HPL) faced chipboard with 100mm front downstand and 75mm rear upstand.

### Flashgaps

18mm nominal thickness melamine faced chipboard (MFC) in a choice of 6 colours.

### Colour finish

**Panels, doors and vanities**  
6 colours.

**Cubicle hardware**  
ABS Graphite.

### Edge treatment

1mm matching PVC.

### Headrail

Graphite U-section aluminium.

### Pedestal

ABS Graphite.

### Accessories

Accessories are in pack C1F.  
See C1F p6.

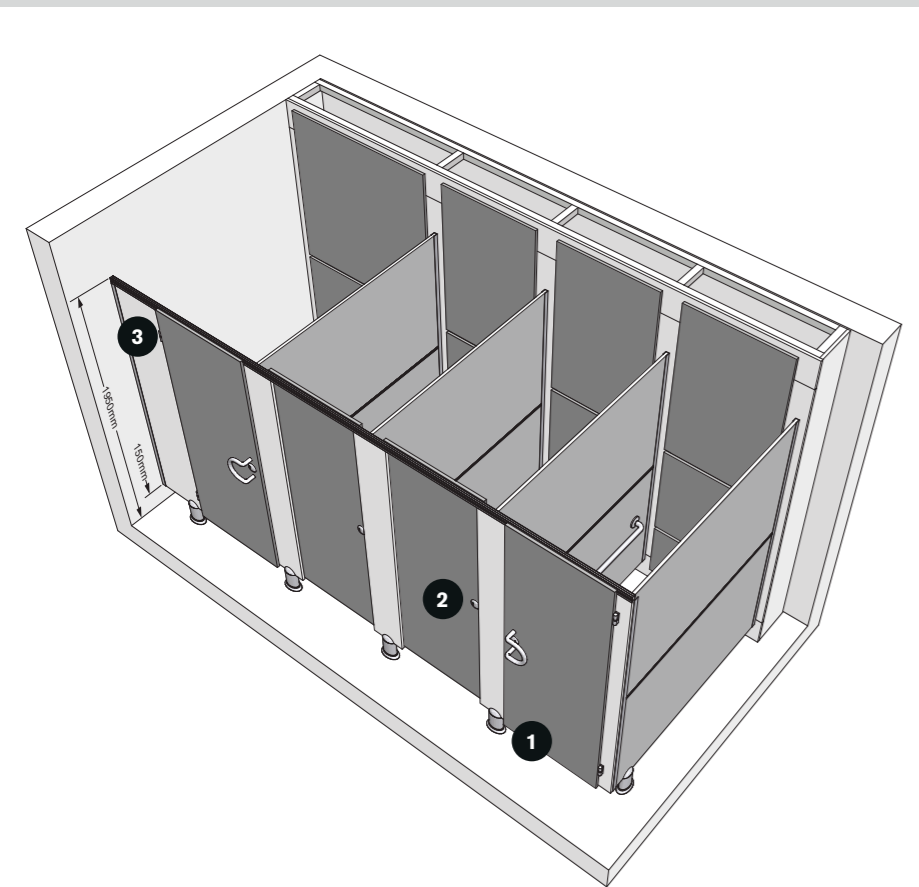

1 Pedestal



2 Indicator bolt



3 Hinge



## Duct panel packs

### Duct panels

All framework by others. The installer needs to provide an appropriate timber-frame to support vanity units (typically ex 50 x 50mm treated softwood).

#### P1 Washbasin and WC panel pack

- 1 bottom panel 405 x 700mm
- 1 middle panel 670 x 700mm
- 1 top panel 1125 x 700mm
- 1 1mm PVC re-edging strip 2500mm
- 16 plastic clips and screws

#### P2 Urinal panel pack

- 1 bottom panel 225 x 700mm
- 1 middle panel 850 x 700mm
- 1 top panel 1125 x 700mm
- 1 1mm PVC re-edging strip 2500mm
- 16 plastic clips and screws

#### P3 Plain panel pack

- 1 plain panel 2250 x 700mm
- 1 1mm PVC re-edging strip 2500mm
- 10 plastic clips and screws

#### P4 Plain panel pack

- 1 plain 2250 x 300mm
- 1 1mm PVC re-edging strip 2500mm
- 10 plastic clips and screws

#### F1 Flashgap pack

- 2 flashgaps – unedged 2600 x 200mm
- 1 flashgap – edged 2600 x 201mm
- 16 shrinkage plates and screws

### Duct panels – standard height

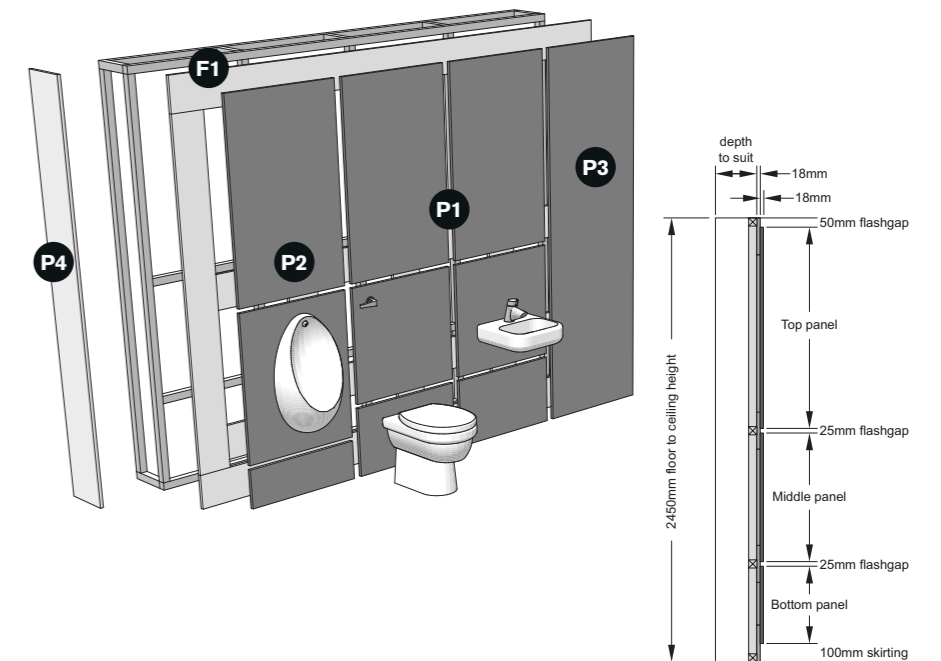

### Duct panels – shelf height

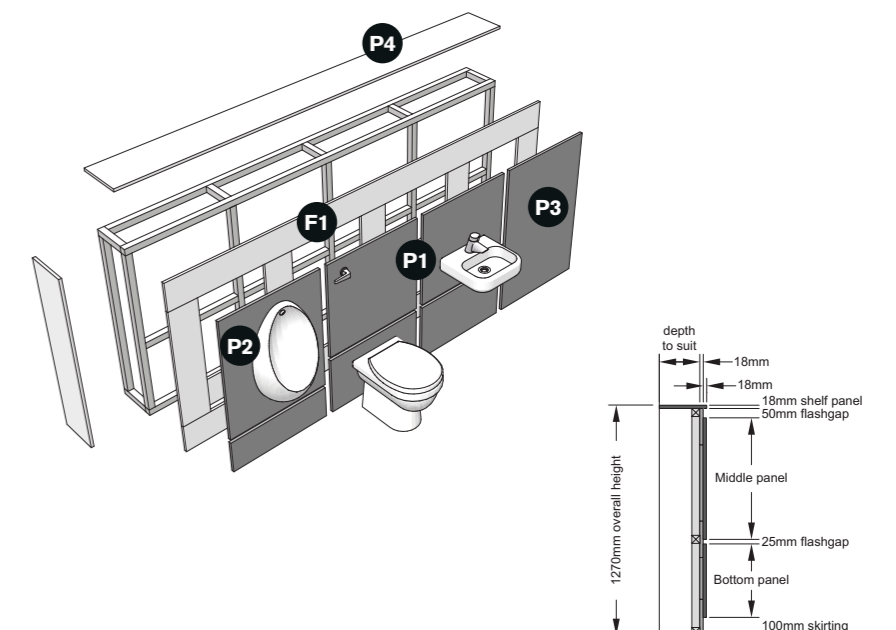

# Technical Specifying Cubicle Express

## Cubicle packs

### Cubicles

Wall channels accommodate out of line walls.

Door and wall channels allow for cutting without the need to re-edge.

Adjustments can be made to cubicles by reducing doors and partitions and fitting into full length door channels or wall channels as appropriate.

**Please note:** floor to ceiling post will be required when ordering free-standing cubicles.

#### C1 Door pack

Outward opening/inward opening wheelchair, ambulant and enlarged.

- 1 door 1800 x 900mm
- 1 square edge pilaster 1800 x 220mm
- 1 square edge pilaster hinged 1800 x 115mm
- 1 square edge pilaster no hinge 1800 x 115mm
- 1 square edge pilaster for enlarged cubicle drilled for hinge 1800 x 400mm
- 3 UPVC door cap/wall channels 1800mm
- 1 aluminium headrail – Graphite 1800mm

(Door pack also available with post-formed pilasters – C1P)

#### C1F Fittings pack

- 1 indicator bolt
- 1 outward keep
- 3 hinges
- 1 toilet roll holder
- 1 coat hook
- 2 pedestals
- 2 buffers
- Screws, plugs and channel through fixings

### Cubicles

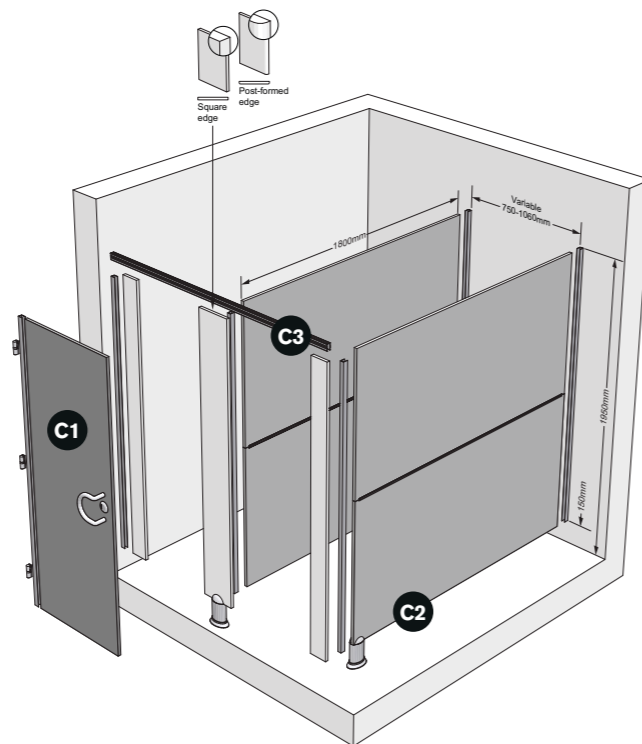

#### C2 Partition pack

- 2 partition 'halves' 900 x 1800mm
- 1 UPVC H-section
- 1 UPVC door cap/wall channel 1800mm

#### C3 Inline pack

- 1 large pilaster 1800 x 900mm
- 1 square edge pilaster drilled hinge 1800 x 550mm
- 1 aluminium headrail – Graphite 1800mm

(Inline pack also available with post-formed pilasters – C3P)

#### C4 Floor to ceiling post

- 1 floor to ceiling post 3750mm
- 2 flanges
- Screws, plugs and channel through bolt fixings

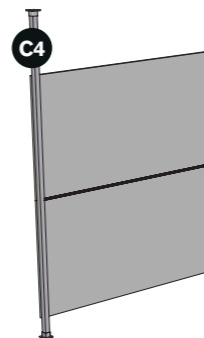

#### GR1 Ambulant/enlarged grab rail pack

- 3 grab rails, White powder coated 600mm
- 2 door opening handles Dark Grey powder coated
- 1 fixing pack complete

## Children's door and vanity unit pack

### Children's doors

#### C1C Children's door pack

- 1 door 1800 x 900mm
- 1 square edge pilaster 1800 x 220mm
- 1 square edge pilaster hinged 1800 x 115mm
- 1 square edge pilaster no hinge 1800 x 115mm
- 1 square edge pilaster for enlarged cubicle drilled for hinge 1800 x 400mm
- 3 UPVC door cap/wall channels 1800mm
- 1 aluminium headrail – Graphite 1800mm

(Children's door pack also available with post-formed pilasters – C1CP)

### Children's doors

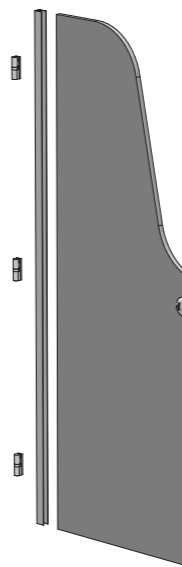

### Vanities

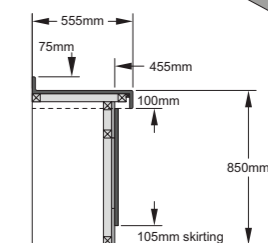
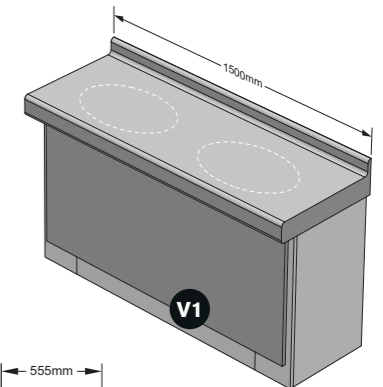

### Children's doors

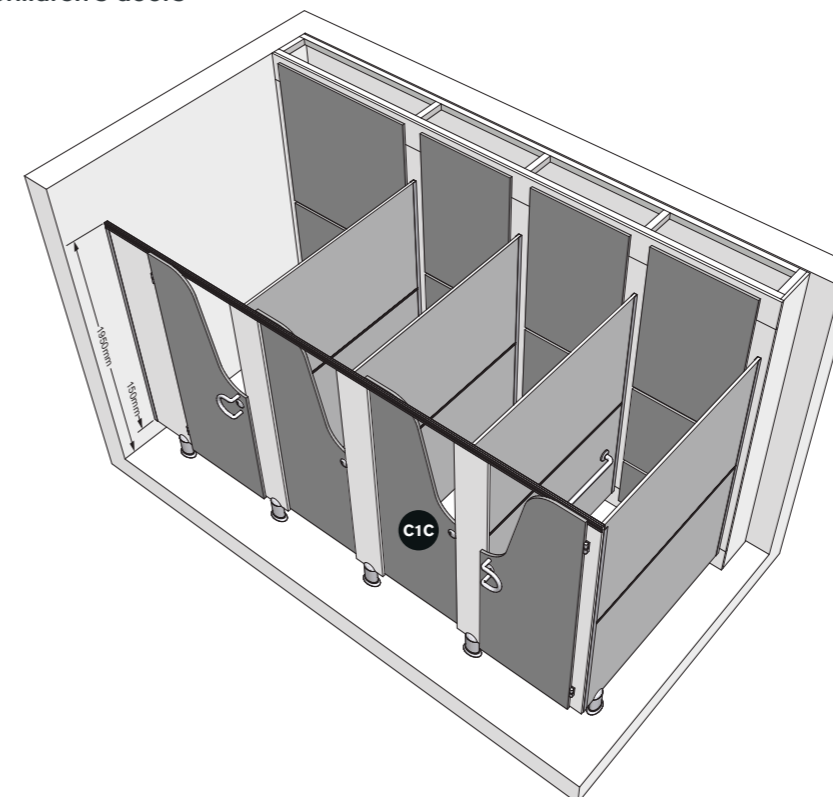

### Vanities

All framework by others. The installer needs to provide an appropriate timber frame to support vanity units (typically ex 50 x 50mm treated softwood).

Longer vanities can be achieved by joining two lengths.

The return end panel for vanity units will be supplied oversized to enable the installer to make onsite adjustments.

#### V1 Vanity unit pack

- 1500 x 555mm top post-formed into a 100mm downstand and a 75mm high upstand blocked both ends
- 1 1400 x 645mm under panel
- Clips and screws
- 3 unedged flashgaps 1300 x 200mm
- Fixing brackets and screws
- 2 loose return ends

# Selecting Cubicle Express

Each product pack (cubicles, duct panels and vanity units) will be supplied fully boxed, clearly labelled, complete with all the necessary fixing components and installation instructions.

## Cubicle selection

- For each set of cubicles, identify which of the layouts suits your project then refer to the grid beside it.
- Read across the top row of the grid until you reach the number of cubicles required.
- Read down the column under the number of cubicles to identify the pack and quantities you require.

**Please note:** minimum cubicle width 750mm.

### Options for all types

- Children's door instead of standard door pack.
- Ambulant/enlarged grab rails and door opening bars are available separately.
- Post-formed pilasters.

## Between walls

Number of cubicles	1	2	3	4	5	6	7	8
Door pack	1	2	3	4	5	6	7	8
Fittings pack	1	2	3	4	5	6	7	8
Partition pack	0	1	2	3	4	5	6	7
Floor/ceiling post pack	0	0	0	0	0	0	0	0
Maximum width - mm	1060	2120	3180	4240	5300	6360	7420	8480

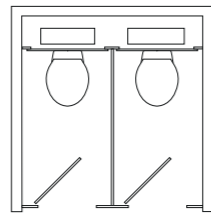

## Freestanding

Number of cubicles	1	2	3	4	5	6	7	8
Door pack	1	2	3	4	5	6	7	8
Fittings pack	1	2	3	4	5	6	7	8
Partition pack	2	3	4	5	6	7	8	9
Floor/ceiling post pack	1	1	1	2	2	2	2	2
Maximum width - mm	1060	2120	3180	4240	5300	6360	7420	8480

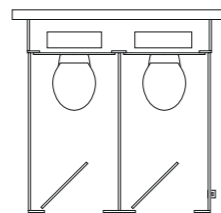

## In wall angle

Number of cubicles	1	2	3	4	5	6	7	8
Door pack	1	2	3	4	5	6	7	8
Fittings pack	1	2	3	4	5	6	7	8
Partition pack	1	2	3	4	5	6	7	8
Floor/ceiling post pack	0	0	0	0	0	0	0	0
Maximum width - mm	1060	2120	3180	4240	5300	6360	7420	8480

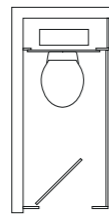

## Inline cubicle

	Between walls	In wall angle
Number of cubicles	1	1
Door pack	1	1
Fittings pack	1	1
Partition pack	0	1
Inline pack	1	1
Maximum length - mm	2000	2000

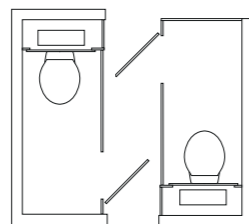

## Vanity selection

- Determine how many vanity basins you require in each top.
 

1500mm long top	Up to 2 basins	Pack V1
-----------------	----------------	---------
- Check that your chosen top will fit into the space available onsite.
- Each vanity pack includes under panel, return end and flashgap. These are all included along with fixings pack.
- The supporting soft wood frame is supplied by others.

## Panel selection

- For each range of panels determine how many you want of each type.
- Check that they will fit into the space available onsite.
  - Always leave a vertical gap 25mm wide between a panel and a wall.
  - Leave a 25mm wide vertical gap between each panel.
  - For WC panels, leave 50mm for fixing a cubicle partition.
  - Plain panel packs P3 and P4 can be cut down and re-edged onsite to cater for ranges that do not accommodate 700mm modules.
- For each panel you will need one flashgap pack.

# Selecting Cubicle colours

With the flexible range of colours offered by Cubicle Express you can contrast pilasters, doors and partitions to create an attractive colour combination. Doors, partitions and duct panels are available in a choice of 6 popular colours.

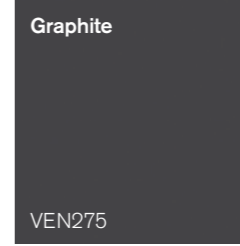
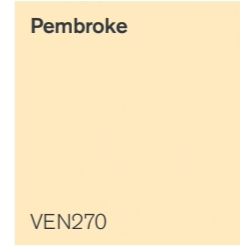
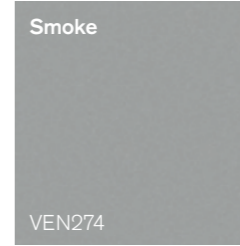
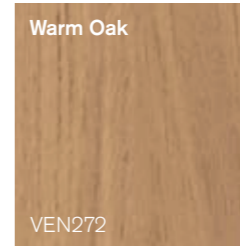
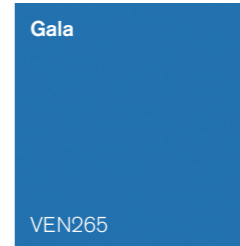

# Accessories

Accessories are available from Venesta.

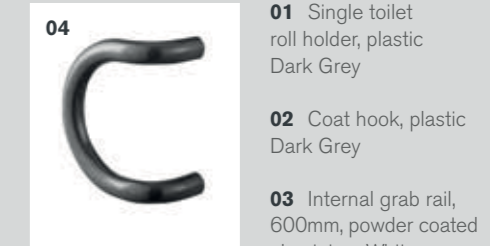

- 01** Single toilet roll holder, plastic Dark Grey
- 02** Coat hook, plastic Dark Grey
- 03** Internal grab rail, 600mm, powder coated aluminium White
- 04** Exterior door handle, powder coated aluminium Dark Grey

**Call us, we're here to help.**  
01474 353333.

[www.venesta.co.uk](http://www.venesta.co.uk)

For help and advice on your requirements, visit our website for a comprehensive guide.

**Our address**

Chartwell Court  
West Mill  
Imperial Business Park  
Gravesend, Kent  
DA11 0DL

Telephone  
01474 353333

Facsimile  
01474 533558

Email  
[marketing@venesta.co.uk](mailto:marketing@venesta.co.uk)

Republic of Ireland  
Telephone  
1 800 931 880

Facsimile  
1 800 931 881

[www.venesta.co.uk](http://www.venesta.co.uk)