

Specialist Retail Security Systems

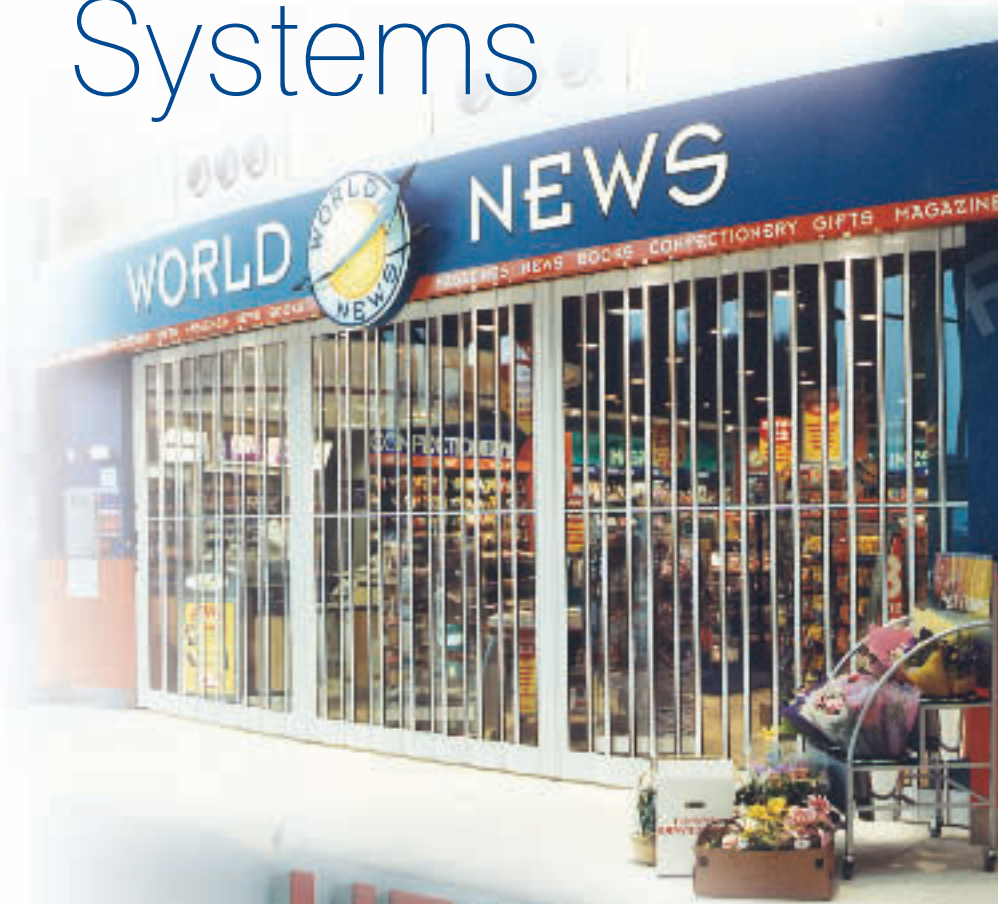

Clear Guard

Ali Glyde



Clear Guard Range



Features

- Ideal for shop front applications with 80% unrestricted view
- UV stabilised for sun protection
- Widths available up to 7200mm

Security

- Manufactured from hard coated polycarbonate, a material which is extremely robust and virtually unbreakable being 250 times stronger than glass of the same thickness.

Operation

- Electric operation powered by single phase tube motor
- Various controls and operator units to automate and secure closing
- Manual override system for operation in the event of power failure

Presentation

- Hinges and guides anodised as standard
- Polyester powder coat finish available on request.



Isometric View

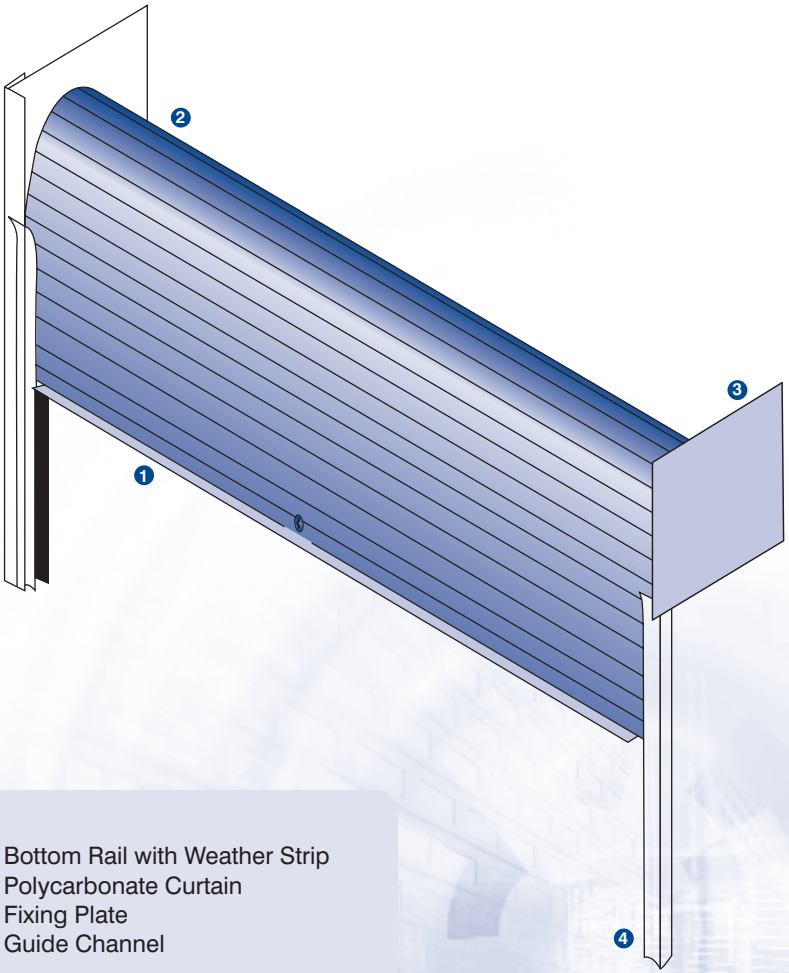

- 1 Bottom Rail with Weather Strip
- 2 Polycarbonate Curtain
- 3 Fixing Plate
- 4 Guide Channel

Typical Layout

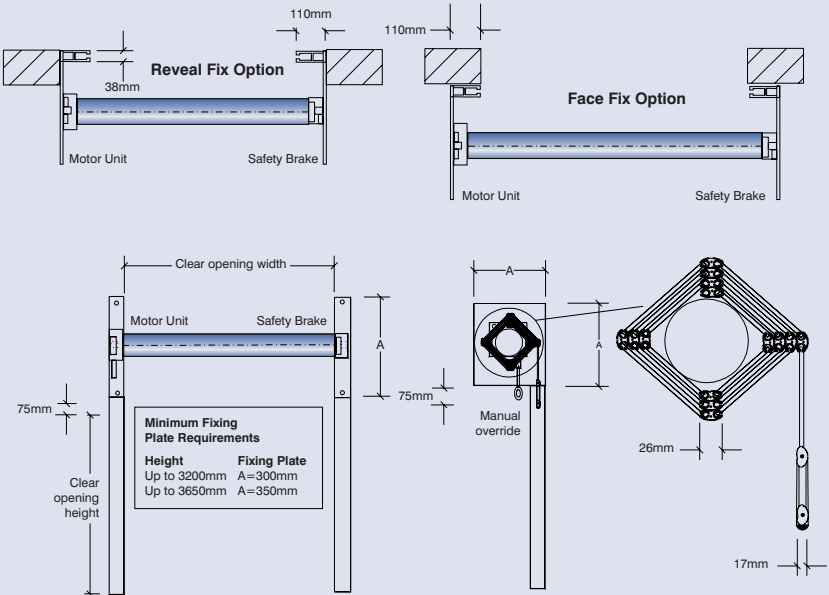

Ali Glyde Range



Feature

- Low maintenance closure system
- Ideal for mall, shop fronts and airports
- Design enables large spans
- Flexible to support curved layouts

Security

- Lock members are integrated 50mm x 32 mm standard extruded aluminium hollow posts
- Adams Rite mortice lock operated by 5 pin cylinder on each side
- Intermediate posts incorporate drop bolts located into flush floor sockets

Operation

- Manual operation on all models (slide aside)
- No requirements for motor or springs

Model Variations and strengths

- 10 Models available with varying aesthetics and security
- Additional option of tempered glass and polycarbonate backing for additional security
- Only 42mm head room with no floor track required

Presentation

- Natural anodised as standard
- Polyester powder coat finish in black, white, medium bronze or light bronze
- Additional colours available on request



Styles and Finishes

Model Styles

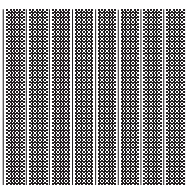

◀ **Aeroflex**
(perforated)

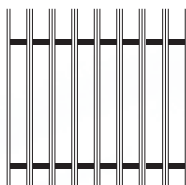

◀ **Royal** (tempered glass)
Impact (polycarbonate)

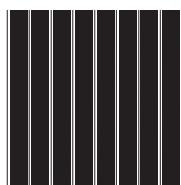

◀ **Global**
(solid)

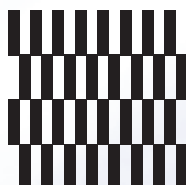

◀ **Concept 1212**

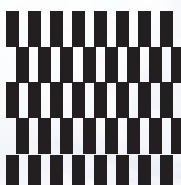

◀ **Concept 99**

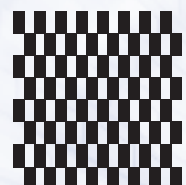

◀ **Concept 66**

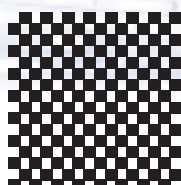

◀ **Concept 33**

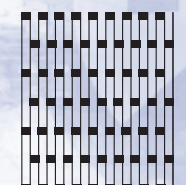

◀ **System S-525**

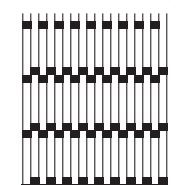

◀ **System S-12**

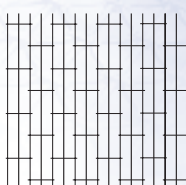

◀ **System 126**

Standard finishes



**Clear
Anodised**

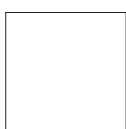

**White
Paint**



**Medium
Bronze
Paint**



**Light
Bronze
Paint**



**Black
Paint**

Isometric View

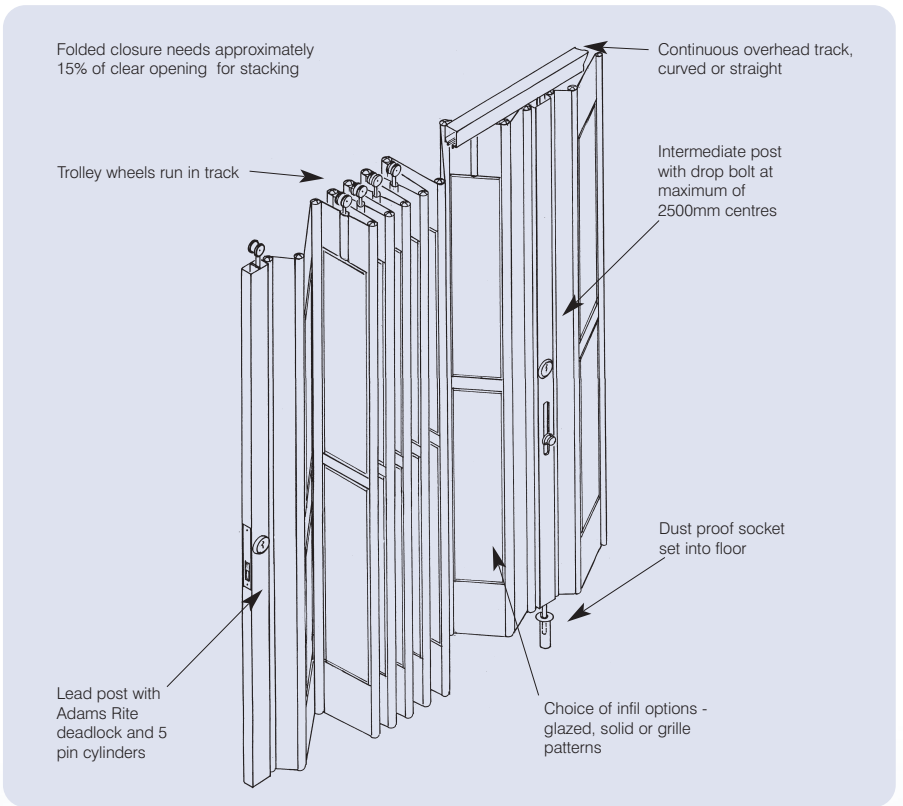

Typical Layout

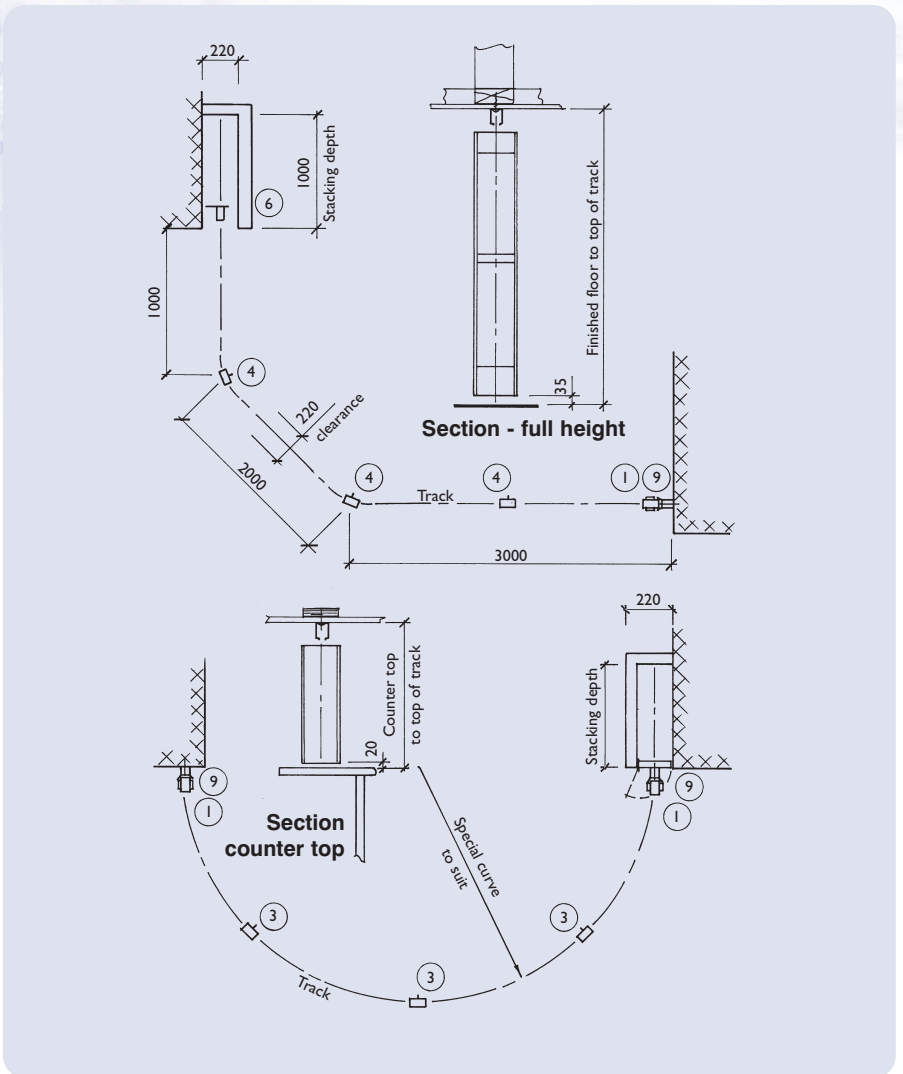

Alternative Stacking Arrangements

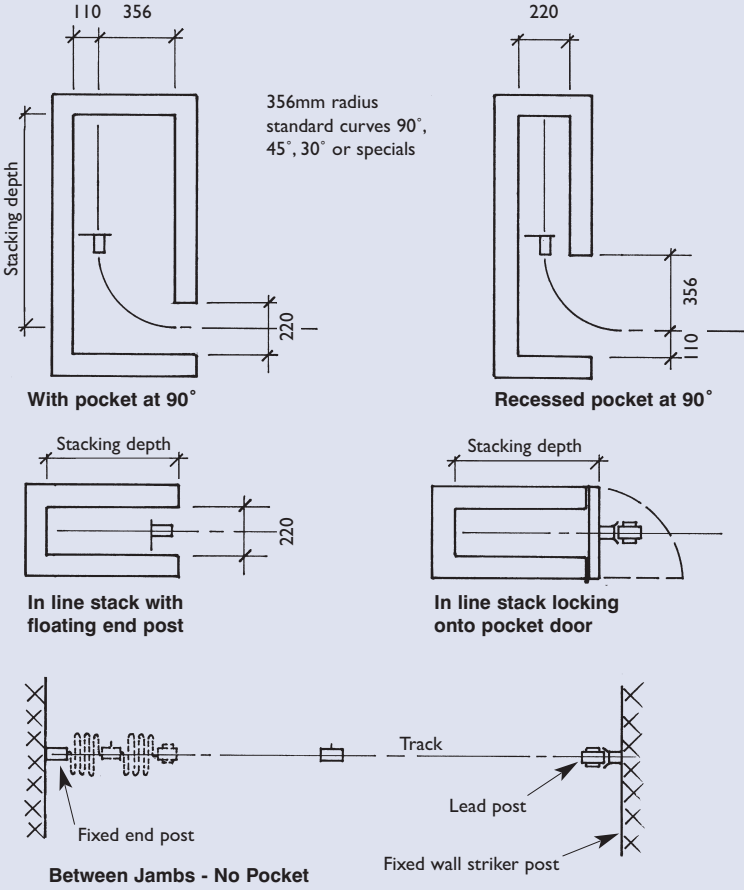

Note There are no floor tracks. Integral intermediate posts are at max 2500mm centres except on counter tops when they are at approximately 1500mm centres. Stacking depth - allow 95mm per 1000mm of clear opening length plus 76mm per post member including the end post, lead post and intermediate posts.

Sections

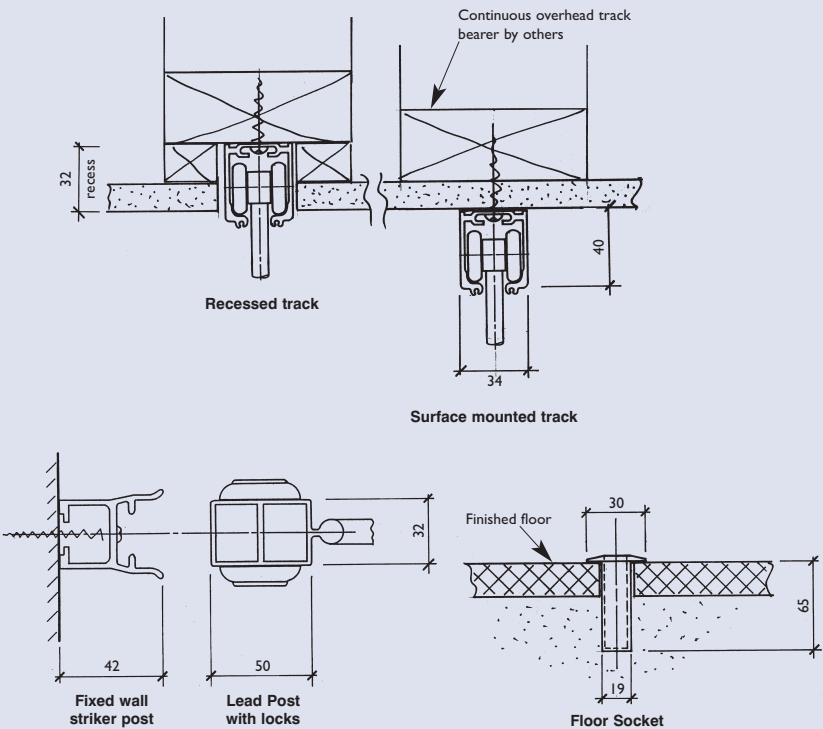



HAG design, manufacture and install a full range of property protection systems for domestic, commercial and industrial applications.

Our dedicated Customer service teams ensure complete satisfaction by providing comprehensive support from ordering to owning HAG products.

After care benefits:

- Nation wide service
- 24 hour repair help line
- Service contracts



Products and Services Range

Home & Office Security

Retractable Security Gates, Window and Door Security Shutters (Built-in/Built-on), Roller Garage Doors

Rolling Security Systems

Armourguard Range, Alishield Range, Diamond Roll Grille, Alulink Grille

Specialist Door Products

Armourguard Industrial Range, Fire Guard, Honeycomb Grille, Q Door, Steel Door

Services

24 Hour Repair, Installation Services, Maintenance Contracts

Associated Products

Steel Fabrication, Iron Bars, Timber Shutters, Clear Polycarbonate Rolling Shutters, Ram Posts, PVC Insulating Strip Curtain

Specialist Retail Security Systems

Clear Guard, Ali Glyde



Eden Project. St Austell Cornwall

NATIONAL ADVICE LINE
0117 965 4888

1 Oak Lane Fishponds Bristol BS5 7UY Tel: 0117 965 4888 Fax: 0117 965 7773

email: info@hag.co.uk website: www.hag.co.uk

DISCLAIMER

HAG operates a policy of continuous improvement. Product specification may change and it is advisable to consult with HAG technical advisors before specifying or ordering.